

Star Trac Fitness™

S-TR Treadmill

S-TRx Treadmill

S-TRc Treadmill

OWNER'S MANUAL



TABLE OF CONTENTS

Introduction	5
ABOUT THIS MANUAL.....	5
Important Safety Instructions	6
ABOUT THIS MANUAL.....	5
Assembly and Setup	19
UNPACKING.....	19
TOOLS REQUIRED	19
ASSEMBLY	19
Operating Instructions.....	23
DISPLAY PANEL FEATURES	23
HINTS AND TIPS FOR GETTING STARTED.....	25
COOLDOWN CYCLE.....	25
USING THE PERSONAL FAN	25
HEART RATE MONITORING	25
LOCKOUT ID PROCESSING.....	26
QUICK START	26
PRESET PROGRAMS	27
ADVANCED WORKOUTS PROGRAMS.....	30
Training Information	37
THE FIRST STEP TO A BETTER LIFESTYLE.....	37
GETTING STARTED - WALKERS AND RUNNERS.....	37
CLIMBING THE CONDITIONING LADDER - SUGGESTED PROGRAMS.....	38
PROGRAM VARIATION ON THE S SERIES TREADMILL.....	39
TIPS TO STAY MOTIVATED.....	40
Preventative Maintenance.....	41
DAILY MAINTENANCE	41
WEEKLY MAINTENANCE.....	41
BI-WEEKLY MAINTENANCE	41

MONTHLY MAINTENANCE.....41

ADJUSTMENTS41

REWAX BELT42

Manager / Maintenance Mode.....44

MANAGER MODE44

MAINTENANCE MODE.....45

Troubleshooting.....49

START-UP SERVICE MESSAGES49

Regulatory Information50

FCC AND OTHER DOMESTIC / INTERNATIONAL REGULATIONS.....50

INTERNATIONAL REGULATIONS50

Copyright 2007. Star Trac by Unisen, Inc. All rights reserved, including those to reproduce this book or parts thereof in any form without first obtaining written permission from Star Trac.

Every effort has been made to keep this information current; however, periodically, changes are made to the information herein, and these changes will be incorporated into new editions of this publication. All product names and logos are trademarks of their respective owners. Printed in the USA.



INTRODUCTION

Thank you for choosing the **STAR TRAC S SERIES TREADMILL**. These Treadmills have been designed to provide the user the most rewarding experience based upon the carefully planned features it possesses. The design elements of these Treadmills will provide you with a comfortable, intuitive, safe and reliable experience, guiding you to a habit-forming lifestyle. Our mission is to provide products to mold lifelong habits for health and fitness, and our Treadmills will provide the path to meet your goals. Enjoy the ride.

ABOUT THIS MANUAL

This manual is applicable to the **STAR TRAC S-TR, S-TRx and S-TRc TREADMILLS**. The manual is divided into eight sections, as follows:

Introduction

Provides an overview of each section within the manual.

Safety Instructions

Provides guidelines, in multiple languages, for safely operating the Star Trac S Series Treadmills.

Assembly and Setup

Provides instructions for unpacking, assembling and setting up the Star Trac S Series Treadmills.

Operating Instructions

Provides a detailed description of the Display Panel, and includes step-by-step instructions for operating the Star Trac S Series Treadmills.

Preventative Maintenance

Describes the preventative maintenance measures required to keep the Star Trac S Series Treadmills in top condition.

Manager / Maintenance Mode

Provides step-by-step instructions for changing universal parameters on Star Trac S Series Treadmills, and for performing built-in testing procedures.

Troubleshooting

Describes the start-up and shutdown messages provided as a result of the self-test routine.

Regulatory Information

Provides regulatory information for the Star Trac S Series Treadmills.

IMPORTANT SAFETY INSTRUCTIONS

When using an electrical appliance, basic precautions should always be followed, including the following: Please read the owner's manual in its entirety before operating the treadmill.

WARNING

- You Star Trac **S-TRc** series Treadmill is designed for aerobic exercise in a gymnasium or health club environment (FOR COMMERCIAL USE).
- You Star Trac **S-TR** and/or **S-TRx** series Treadmill is designed for aerobic exercise in the comfort of your home (FOR HOUSEHOLD USE ONLY). Children should be supervised to ensure that they do not play with the appliance.
- Please check with your physician prior to beginning any exercise program. Do not push yourself to excess. Stop if you are feeling faint, dizzy, or exhausted.
- Use common sense when walking or running on a treadmill.

DANGER – To reduce the risk of electric shock:

1. Always unplug this appliance from the electrical outlet immediately after using and before cleaning.

WARNING – To reduce the risk of burns, fire, electric shock, or injury to persons:

1. An appliance should never be left unattended when plugged in. Unplug from outlet when not in use, and before putting on or taking off parts.
2. This appliance is not intended for use by persons (including children) with reduced physical, sensory or mental capabilities, or lack of experience and knowledge, unless they have been given supervision or instruction concerning use of the appliance by a person responsible for their safety.
3. Close supervision is necessary when this appliance is used by, on, or near children, invalids, or disabled persons.
4. Use this appliance only for its intended use as described in this manual. Do not use attachments not recommended by the manufacturer.
5. Never operate this appliance if it has a damaged cord or plug, if it is not working properly, if it has been dropped or damaged. Contact Star Trac service support for examination and repair.
6. Do not carry this appliance by supply cord or use cord as a handle.
7. Keep the cord away from heated surfaces.
8. Never operate the appliance with the air openings blocked. Keep the air openings free of lint, hair, and the like.
9. Never drop or insert any object into any opening.
10. Do not use outdoors.
11. Do not operate where aerosol (spray) products are being used or where oxygen is being administered.
12. To disconnect, turn all controls to the off position, then remove plug from outlet.

SAVE THESE INSTRUCTIONS

GROUNDING INSTRUCTIONS

This product must be grounded. If it should malfunction or breakdown, ground provides a path of least resistance for electrical current to reduce the risk of electrical shock. This product is equipped with a cord having an equipment-grounding conductor and a grounding plug. The plug must be plugged into an appropriate outlet that is properly installed and grounded in accordance with local codes and ordinances.

DANGER - Improper connection of the equipment-grounding conductor can result in a risk of electric shock. Check with a qualified electrician or serviceman if you are in doubt as to whether the product is properly grounded. Do not modify the plug provided with the product. If the product must be reconnected for use on a different type of electric circuit, the reconnection should be made by qualified service personnel in order to avoid a hazard.

For models **9-3561-MUSAP0**



This product is rated more than 15 amperes and is for a circuit having a nominal rating of 120-volt and is factory-equipped with a specific electric cord and plug to permit connection to a proper electrical circuit. Make sure that the product is connected to an outlet having the same configuration as the plug. No adapter should be used with this product. If the product must be reconnected for use on a different type of electric circuit, the reconnection shall be made by qualified personnel.

For models **9-3543-MUSAP3; 9-3553-MUSAP3, AND 9-2543-MCOSP3**

This product is for use on a nominal 120-volt circuit and has a grounding plug that looks like the plug illustrated in sketch A in the following figure. Make sure that the product is connected to an outlet having the same configuration as the plug. If a grounding adapter is needed, the work should be made by qualified service personnel. Sketch B shows a sample of an acceptable grounding method.

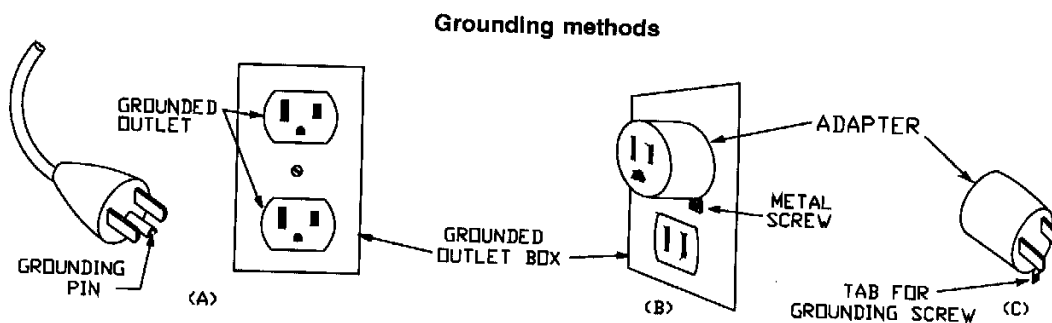

BEFORE YOU START

Safety precautions are provided in the following languages (in the order shown):

- English,
- Dutch,
- French,
- German,
- Italian,
- Portuguese,
- Spanish,
- Swedish

PRECAUTIONS



CAUTION: READ THE OWNER'S MANUAL COMPLETELY BEFORE OPERATING THIS TREADMILL.

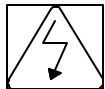

CAUTION: BEFORE CLEANING OR SERVICING, DISCONNECT POWER SUPPLY.

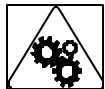

CAUTION: MOVING PARTS, KEEP HANDS AND FEET FROM UNDER THE TREADMILL WHEN OPERATING.



STOP (OF ACTION)



ON

OFF

These safety notes are directed to you as the owner of the **STAR TRAC S SERIES TREADMILL**. Please train all your users and fitness staff to follow these safety instructions.

Do

- Do encourage your members to discuss their health program or fitness regimen with a health care professional, especially if they have not exercised for several years, are over 35, or have known health conditions.
- Do read all instructions in this manual before using your treadmill.
- Do use your treadmill only for its intended use, as described in this manual.
- Do check to ensure the belt is not moving prior to using the treadmill.
- Do keep the belt surface clean and dry.
- Do stop operating your treadmill if you feel dizzy, faint or exhausted.
- Do exercise slowly until you reach a level of comfort and security.
- Do be aware of the location and proper use of the emergency STOP key.
- Do perform regular preventive maintenance as suggested in the manual.
- Do keep the electrical cord away from sources of excessive heat.
- Do keep the treadmill air openings free of lint, hair, etc.
- Do unplug your treadmill before doing any maintenance or cleaning.
- Do warm up and cool down before and after each workout.
- Do set your goals.
- Do complement your walking, jogging, and running with a nutritious diet.
- Do try charting your progress using the feedback from your treadmill.
- Do try using the incline feature to burn more calories and strengthen your lower-body muscles.

Do Not

- Do not let children operate your treadmill. Supervise invalids or disabled persons who use your treadmill.
- Do not leave your treadmill unattended when it is plugged in. Unplug it from the outlet when it is not in use, and before you remove or replace any parts or accessories.
- Do not use your treadmill without athletic shoes.
- Do not wear loose or hanging clothing while using the treadmill.
- Do not step or jump on or off your treadmill if the belt is moving.
- Do not use or store your treadmill outdoors or in an enclosed pool environment.
- Do not ever drop or insert any object, hands, or feet into any opening, or underneath this equipment.
- Do not place water bottles or cups on your treadmill unless you are using the designed holders for the treadmill. Do not use your treadmill where aerosol (spray) products are being used or where oxygen is being administered.
- Do not use attachments or parts not recommended by the manufacturer.
- Do not run the equipment with the motor shroud removed, or modify the equipment in any way.
- Do not overtighten the running belt.
- Do not operate your treadmill if it has a damaged cord or plug, if it is not working properly, if it has been dropped or damaged, or if the display shows an error code. Call your dealer or Star Trac at (800) 503-1221, or USA 1-714-669-1660 for service.

VEILIGHEIDSINSTRUCTIES



VOORZICHTIG: NEEM DE STEKKER UIT HET STOPCONTACT VOOR HET RENIGEN OF ONDERHOULD.

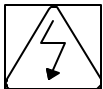

VOORZICHTIG: LEES HET INSTRUCIEHANDBOEK VOORDAT U DE MACHINE BEDIENT.

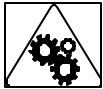

VOORZICHTIG: BEWEGENDE ONDERDELEN, HOUD EN VOETEN ONDER DE LOPENDE BAND VANDAAN.



STOPPEN (VAN ACTIE)



AAN

UIT

WAARSCHUWING

Dit produkt is voor gebruik op een circuit met een nominale waarde van 220 volt en is in de fabriek uitgerust met een speciaal elektrisch snoer en stekker om verbinding met een passend elektrisch circuit toe te staan. Zorg ervoor dat dit produkt verbonden is met een stopcontact dat dezelfde configuratie heeft als de stekker. **GEBRUIK GEEN ADAPTER BIJ DIT PRODUCT.** Als het produkt opnieuw verbonden moet worden met een ander type van elektrisch circuit, dan moet deze verbinding gemaakt worden door gekwalificeerd onderhoudspersoneel.

Deze veiligheidsinstructies zijn aan u gericht als de eigenaar van de **STAR TRAC S REEKS-HARDLOOPBAND**. Train uw leden en fitness-personeel om deze veiligheidsinstructies te volgen.

LEES ALLE INSTRUCTIES VOORDAT U DE HARDLOOPBAND GEBRUIKT.

WAARSCHUWING: Om het risico van een elektrische schok te verminderen, dient u de stekker van de hardloopband **ALTIJD** uit het stopcontact te nemen voordat u hem schoonmaakt.

Doe Dit Wel

- Stop de bediening van de hardloopband als u zich duizelig voelt of het gevoel heeft dat u flauwvalt.
- Weet hoe ver u kunt gaan.
- Zorg ervoor dat het oppervlak van de band schoon en droog blijft.
- Neem de stekker uit het stopcontact voordat u de band reinigt of welk onderdeel dan ook verwijdert of vervangt. Gebruik dit product alleen voor het doeleinde waarvoor het bestemd is.
- Zorg ervoor dat u weet waar de noodstop zit en hoe deze werkt.
- Verricht regelmatig preventief onderhoud.
- Houd het snoer bij verwarmingssystemen vandaan.
- Wacht totdat de lopende band stil staat voordat u van de hardloopband stapt.
- Houd luchtopeningen vrij van pluizen, haar etc. Bedien de hardloopband nooit met beblokkeerde luchtopeningen.
- Schakel de stroom uit bij de contactschakelaar.

Doe Dit Neit

- Laat kinderen niet zonder toezicht de hardloopband bedienen.
- Ga de band niet op af terwijl deze loopt.
- Niet buiten gebruiken.
- Draag geen loszittende kleding als u de lopende band bedient.
- Draai de lopende band niet te strak aan.
- Bedien de hardloopband niet als deze een beschadigd snoer of stekker heeft, als hij niet goed werkt of als hij gevallen of beschadigd is. Neem contact op met uw geautoriseerde STAR TRAC detailhandelaar of de onderhoudsafdeling van STAR TRAC op +1 (714) 669-1660 of bezoek onze website op <http://www.startrac.com> voor een onmiddellijke inspectie of reparatie.
- Gebruik de hardloopband niet zonder gymschoenen. Laat nooit objecten in het apparaat vallen en steek geen objecten, handen of voeten in welke opening van het apparaat dan ook of onder het apparaat.
- Plaats geen waterflessen of bekers op uw hardloopband tenzij u een houder heeft die speciaal ontworpen is voor hardloopbanden. Gebruik uw hardloopband niet in een omgeving waar spuitbussen worden gebruikt of waar zuurstof wordt toegevoerd.
- Bedien het apparaat niet zonder de motorafscherming of pas het apparaat op geen enkele wijze aan.

MESURES DE PRECAUTION



ATTENTION: LISEZ SOIGNEUSEMENT LE MANUEL D'UTILISATION AVANT D'UTILISER CE TAPIS ROULANT.

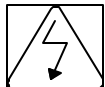

ATTENTION: DÉBRANCHEZ A LA SOURCE AVANT D'EFFCTUER UN ENTRETIEN DU UNE RÉPARATION.

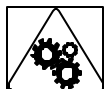

ATTENTION: CONTIENT DES PIÈCES MOBILES. GARDEZ LES MAINS ET LES PIEDS A L'ECART DE LA PARTIE INFÉRIEURE DU TAPIS ROULANT PENDANT SON FONCTIONNEMENT.



ARRÊT (MISE HORS SERVICE)



OUVRE

FERME

Ces instructions sont destinées au propriétaire du **TAPIS STAR TRAC S**. Assurez vous que votre personnel et vos adhérents les suivent toujours.

À Faire

- Encouragez vos adhérents à parler de leur programme d'entraînement à un médecin ou un entraîneur, en particulier s'ils n'ont pas eu d'activité sportive pendant plusieurs années, s'ils ont plus de 35 ans ou s'ils ont des kilos superflus.
- Lisez le manuel avant faire fonctionner le tapis.
- Utilisez le tapis exclusivement aux fins don't il est destiné. N'utilisez pas d'accessoires qui n'ont pas été recommandés par le fabricant.
- Attachez toujours vos lacets et vêtements quand vous courez sur le tapis.
- Conserver la surface du tapis propre et sèche.
- Arrêtez si vous êtes pris de vertiges ou épuisé.
- Commencez toujours à une vitesse lente.
- Respectez les périodes d'échauffement et de récupération.
- Vérifier où se trouve l'interrupteur STOP d'urgence et comment l'utiliser correctement.
- Entrez vos objectifs.
- Complétez votre entraînement par un régime alimentaire.
- Suivez votre progrès grâce aux informations du tableau de bord.
- Essayez d'utiliser l'inclinaison afin de brûler plus de calories et de renforcer les muscles de membres inférieurs.
- Effectuez régulièrement l'entretien préventif du tapis.
- Mettez les fils électriques à l'abri de chaleur.
- Enlevez poussière, cheveux etc. de l'aération.

À Ne Pas Faire

- Ne laissez pas d'enfants non-accompagnés sur le tapis. Une surveillance très stricte est nécessaire si des personnes invalides ou handicapées utilisent le tapis.
- Ne laissez jamais le tapis sans surveillance s'il est branché. Débranchez le tapis si vous ne l'utilisez pas ou avant de monter ou démonter des pièces.
- Ne pas porter de vêtements larges ou pendants lors de l'utilisation du tapis roulant.
- Utilisez le tapis uniquement avec des chaussures appropriées.
- Ne descendez pas ou ne montez pas sur un tapis qui est en fonction.
- N'utilisez ou ne stockez jamais le tapis à l'extérieur ou près d'une piscine.
- Ne laissez rien rentrer dans les ouvertures. Ne posez pas vos pieds sous l'appareil.
- Ne posez pas de bouteilles ou verres d'eau sur l'appareil sans être équipé avec le en option.
- N'utilisez pas le tapis dans les endroits où des aérosols ou de l'oxygène ont été utilisés.
- Débranchez le tapis avant le nettoyage ou le changement de fusibles.
- N'enlevez pas de vis, ne modifiez pas l'appareil.
- Ne serrez pas trop fort la surface caoutchoutée.
- N'utilisez pas cet appareil si les fils ou la fiche sont endommagés, s'il est tombé ou cassé. Appelez votre distributeur pour une révision ou réparation.

SICHERHEITSVORSCHRIFTEN



ACHTUNG: GERÄT VOR DEM REINIGEN ODER WARTEN VON DER STROMVERSORGUNG TRENNEN.

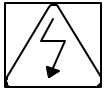

ACHTUNG: VOR DER BENUTZUNG SICHERHEITSVORSCHRIFTEN LESEN.

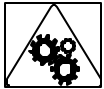

ACHTUNG: BEWEGLICHE TEILE, BEI BETRIEB HÄNDE UND FÜSSE VOM BEREICH UNTER HALB DES LAUFBANDES FERN HALTEN.



BEDIENUNG UNTERBRECHEN



EIN

AUS

WARNUNG

Dieses Produkt ist für den Gebrauch an einer passenden Netzsteckdose mit 220 Volt Spannung bestimmt und werkseitig mit einer dafür vorgesehenen Netzleitung und einem Netzstecker ausgerüstet. Stellen Sie sicher, daß das Gerät nur an einem Anschluß mit gleicher Bauart wie der Stecker angeschlossen wird. VERWENDEN SIE DEINEN ADAPTER FÜR DEN BETRIEB DES PRO / PRO S. Wenn das Gerät zum Betrieb an einem anderen Stromnetz auf einen anderen Netzstecker umgerüstet werden muß, sollte die Umrüstung durch einen qualifizierten Elektriker durchgeführt werden.

Diese Sicherheitshinweise sind an Sie, den Besitzer des **LAUFBANDES STAR TRAC S**, gerichtet. Bitte weisen Sie Ihre Mitglieder und Ihre Fitneß-Mitarbeiter an, sich an die folgenden Sicherheitsvorschriften zu halten.

LESEN SIE ALLE ANWEISUNGEN VOR DER BENUTZUNG DEL LAUFBANDES.

WARNUNG: Um das Risiko eines elektrischen Schlages zu vermeiden, nehmen Sie den Stecker des Laufbands vor dem Reinigen **IMMER** aus der Netzsteckdose.

Sie Sollten

- Die Benutzung des Laufbandes beenden, wenn Schwindel oder Benommenheit auftritt.
- Au Ihre Grenzen denken.
- Das Laufband vor jeglichen Wartungsund Reinigungsarbeiten abschalten.
- Das Gerät nur für den vorgesehenen Verwendungszweck benutzen.
- Halten Sie die Oberfläche des Bandes sauber und trocken.
- Informieren Sie sich über den Ort und die korrekte Verwendung des Stoppschalters für den Notfall.
- Regelmäßige vorbeugende Wartungsarbeiten durchführen.
- Die elektrischen Leitungen von Wärmequellen fernhalten.
- Den Stillstand des Laufriemens abwarten, bevor Sie das Laufband auseinanderbauen.
- Die Lüftungsöffnungen frei von Staub, Haaren und Ähnlichem halten.
- Das Laufband niemals mit verdeckten Lüftungsschlitzen betreiben.
- Die Stromversorgung immer am Netzschalter abschalten.

Sie Sollten Niemals

- Kinder das Laufband unbeaufsichtigt benutzen lassen.
- Schutzvorrichtungen entfernen oder das Gerät umbauen.
- Tragen Sie keine lockere oder herabhängende Kleidung, wenn Sie das Laufband benutzen.
- Das Gerät im Freien benutzen.
- Den Laufriemen überspannen.
- Das Laufband mit beschädigter Netzleitung betreiben, wenn es nicht richtig funktioniert, heruntergefallen ist oder beschädigt wurde. Für sofortige Reparaturunterstützung kontaktieren Sie einen autorisierten Händler oder den Kundendienst von **STAR TRAC** telefonisch unter +1 714 669 1660, bzw. Benutzen Sie unsere Web-Seite unter <http://www.startrac.com>.
- Das Laufband ohne die passenden Sportschuhe benutzen.
- Gegenstände in eine Öffnung am Gerät hineinfallen lassen.
- Gegenstände, Hände oder Füße in eine Öffnung am Gerät stecken oder diese unter das Gerät legen.
- Wasserflaschen oder Trinkbecher auf das Laufband stellen, es sei denn, Sie haben ein speziell für diesen Zweck und für dieses Laufband gedachtes Zubehörteil.
- Das Laufband in Räumlichkeiten benutzen, in denen Produkte in Aerosoldosen (Sprays) angewandt werden oder in denen Sauerstoff verabreicht wird.

- Das Laufband mit abgenommener Motorabdeckung laufen lassen, oder das Gerät auf irgendeine Art und Weise verändern.

ISTRUZIONI DI SICUREZZA



ATTENZIONE: PRIMA DI PULIRE O ESEGUIRE LA MANUTENZIONE, TOGLIETE LA SPINA.

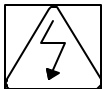

ATTENZIONE: PRIMA DI USARE LEGGETE IL MANUALE DELLE ISTRUZIONI.

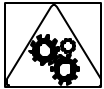

ATTENZIONE: PARTI IN MOVIMENTO. DURANTE IL FUNZIONAMENTO DEL TREADMILL ALLONTARE MANI E PIEDI DAL SUO RAGGIO D'AZIONE.



FERMA IL MOVIMENTO



ACCESO

SPENTO

ATTENZIONE

Questo prodotto è da usare su un circuito elettrico con una tensione nominale di 220 volt ed è fornito dalla fabbrica con un cavo elettrico e spina specifici per permettere il collegamento ad un circuito elettrico appropriato. Assicuratevi che il prodotto sia collegato ad una presa che abbia la stessa configurazione della spina. **NESSUN ADATTATORE DEVE ESSERE USATO CON QUESTO PRODOTTO.** Se il prodotto deve essere ricollegato per l'uso su un circuito elettrico diverso, il ricollegamento deve essere effettuato da un elettricista qualificato.

Queste indicazioni sono indirizzate ai proprietari del **TREADMILL STAR TRAC S**. Chiedete a tutti I membri della vostra palestra e al vostro staff di seguire queste istruzioni di sicurezza.

LEGGETE TUTTE LE ISTRUZIONI PRIMA DI USARE IL TREADMILL.

ATTENZIONE: per ridurre il rischio di scossa elettrica, staccate **SEMPRE** la spina della corrente del treadmill prima di pulirlo.

Da Fare

- Fermate il treadmill se vi sentite svenire o avete capogiri.
- Siate coscienti dei vostri limiti.
- Mantenere il nastro asciutto e pulito.
- Staccate la spina prima di pulire, spostare o cambiare qualsiasi parte del treadmill.
- Usate questo prodotto solo per l'uso inteso.
- Assicuratevi di essere a conoscenza della posizione e dell'uso corretto del pulsante di emergenza STOP.
- Eseguite la manutenzione regolare.
- Mantenete la corda elettrica lontana da fonti di calore.
- Aspettate fino a quando il nastro è completamente fermo prima di scendere dal treadmill.
- Pulite le prese d'aria da polvere, capelli e simili. Non usate mai il treadmill con le prese d'aria bloccate.
- Spegnete la macchina tramite l'interruttore.

Da Non Fare

- Non permettete a bambini di usare il treadmill senza sorveglianza.
- Non salite o scendete dal treadmill mentre è in funzione.
- Non usatelo all'aperto.
- Durante l'uso del treadmill non indossare indumenti che possano impigliarsi in organi in movimento.
- Non tirate troppo il nastro.
- Non usate il treadmill se il cavo elettrico o la spina sono danneggiati, se non funziona come dovrebbe o se è caduto o è danneggiato. Contattate il vostro rivenditore autorizzato **STAR TRAC** o l'assistenza clienti dello **STAR TRAC** al numero +1 714 669 1660 o visitate il nostro sito Internet a <http://www.startrac.com>, per esame o riparazione immediata.
- Usate il treadmill solo se calzate scarpe da ginnastica.
- Non lasciate cadere oggetti e non inserite mani o piedi nelle aperture o al di sotto del treadmill.
- Non appoggiate bottiglie d'acqua o bicchieri sul treadmill a meno che non stiate usando un supporto progettato appositamente per il treadmill.
- Non usate il treadmill in posti dove sono usati prodotti aerosol (spray) o dove è somministrato dell'ossigeno.

- Non accendete il treadmill con il coperchio del motore rimosso, e non modificalo in nessun modo.

INSTRUÇÕES DE SEGURANÇA



ATENÇÃO: ANTES DE LIMPAR OU FAZER MANUTENÇÃO, DESCONECTE O APARELHO DA TOMADA DA.

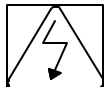

ATENÇÃO: LEIA O MANUAL DE INSTRUÇÕES ANTES DE OPERAR A ESTEIRA.

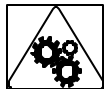

ATENÇÃO: PROTEJA AS MÃOS E OS PÉS AO MOVER PEÇAS COM A ESTEIRA EM FUNCIONAMENTO.



PARE (A AÇÃO)



1 LIGAR

0 DESLIGAR

ADVERTÊNCIA

Este produto deve ser usado em um circuito com tensão nominal de 220 volts. Ele foi fabricado com um cabo de alimentação e plugue específicos para permitir a sua conexão com um circuito elétrico apropriado. Certifique-se de que o produto esteja conectado a uma tomada com as mesmas configurações do plugue. **NÃO UTILIZE ADAPTADORES PARA ESTE PRODUTO.** Se for necessário reconectar a produto para utilização em um tipo diferente de circuito elétrico, este procedimento deverá ser executado por pessoal qualificado.

Estas observações de segurança destinam-se à você, proprietário de **ESTEIRA STAR TRAC S**. Treine todos os membros e funcionários que utilizarão o equipamento para que sigam estas instruções de segurança.

LEIA TODAS AS INSTRUÇÕES ANTES DE USAR SUA ESTEIRA

ADVERTÊNCIA: para reduzir os rescos de choque elétrico, **SEMPRE** desconecte a esteira da tomada antes de limpá-la

Faça

- Pare de usar a esteira se você se sentir fraco ou com tontura.
- Conserve a superfície da correia limpa e seca.
- Reconheça seus limites.
- Desconecte a esteira da tomada antes de limpá-la ou antes de remover ou substituir qualquer peça.
- Utilize este equipamento única e exclusivamente para o seu devido fim.
- Informe-se sobre a posição e o uso adequado da chave de emergência STOP.
- Faça manutenção preventiva regularmente.
- Mantenha o fio afastado de superfícies aquecidas.
- Espere até que a esteira esteja completamente parada antes de descer do aparelho.
- Mantenha as saídas de ar desobstruídas de fiapos de tecidos, cabelos e outros objetos. Nunca opere a esteira com as saídas de ar bloqueadas.
- Desligue o aparelho com o interruptor de força.

Não Faça

- Não permita que crianças operem a esteira sem supervisão de um adulto.
- Não suba ou desça da esteira enquanto ela estiver em movimento.
- Não use roupas folgadas enquanto estiver utilizando a esteira.
- Não utilize a esteira ao ar livre.
- Não estique demais o tapete da esteira.
- Não opere esta esteira se o cabo de alimentação ou o plugue da tomada estiverem danificados, se ela não estiver funcionando perfeitamente ou se tiver sofrido queda ou danos. Procure seu revendedor autorizado STAR TRAC ou o departamento de assistência técnica STAR TRAC pelo telefone 1 714 669 1660 ou acesse nosso "web site" no endereço <http://www.startrac.com> para fazer uma consulta ou conserto imediato.
- Não utilize a esteira sem calçar tênis.
- Não deixe cair nem introduza nenhum objeto, as mãos ou pés em nenhuma abertura do equipamento ou debaixo deste.
- Não coloque garrafas d'água nem copos na esteira se não estiver utilizando o devido acessório projetado para esse fim. Não utilize a esteira onde estejam sendo usados produtos de aerosol (spray) ou em lugares onde esteja sendo administrado oxigênio. Não opere o equipamento com a tampa do motor removida nem faça nenhuma modificação no equipamento.

INSTRUCCIONES DE SEGURIDAD



ATENCIÓN: DESCONECTE EL SUMINISTRO DE CORRIENTE ANTES DE LIMPIAR O REPARAR.

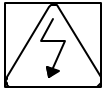

ATENCIÓN: LEA EL MANUAL DE INSTRUCCIONES ANTES DE SU UTILIZACIÓN.

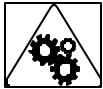

ATENCIÓN: PIEZAS EN MOVIMIENTO! MANTENGA LAS MANOS Y LOS PIES ALEJADOS DE LA PARTE INFERIOR DE LA CINTA CUANDO LA MISMA ESTÉ EN FUNCIONAMIENTO.



PARAR (EL FUNCIONAMIENTO)



ENCENDIDO



APAGADO

ADVERTENCIA

Este producto está preparado para utilizarse en un circuito de 220 voltios y se suministra equipado de fábrica con un cable y un enchufe eléctricos específicos para permitir su conexión a un circuito eléctrico apropiado. Asegúrese de que el producto se conecte a una toma de corriente con la misma configuración que el enchufe. **NO UTILICE NINGÚN ADAPTADOR CON ESTE PRODUCTO.** Si este producto necesita ser modificado eléctricamente para utilizarse en un tipo diferente de circuito eléctrico, dicha modificación debe ser realizada únicamente por el personal de servicio calificado.

Estas notas sobre seguridad van dirigidas a Vd. Como propietario del **TAPIZ RODANTE STAR TRAC S**. Haga que todos los usuarios y preparadores físicos cumplan estas instrucciones de seguridad.

LEA TODAS LAS INSTRUCCIONES ANTES DE UTILIZAR SU TAPIZ RODANTE.

ADVERTENCIA: Para reducir los riesgos de sufrir una descarga eléctrica, desenchufe **SIEMPRE** el tapiz rodante antes de limpiarlo.

Qué Hacer

- Detenga el tapiz rodante si se nota desfallecido o mareado.
- Mantenga la superficie de la cinta seca y limpia.
- Conozca sus limitaciones.
- Desenchufe el tapiz rodante antes de limpiar, quitar o cambiar alguna pieza.
- Asegúrese de saber dónde está el interruptor de emergencia STOP y cómo utilizarlo adecuadamente.
- Utilice este producto sólo para los usos que está diseñado.
- Realice un mantenimiento preventivo de manera regular.
- Mantenga el cable separado de fuentes de calor.
- Espere a que la cinta móvil haya parado antes de descender del tapiz rodante.
- Mantenga las entradas de aire libres de pelusa, pelo y similares. No utilice nunca el tapiz rodante con las entradas de aire bloqueadas.
- Desconecte de la corriente por medio del disyuntor.

Qué No Hacer

- No permita que los niños utilicen el tapiz rodante sin supervisión.
- No suba o baje del tapiz rodante mientras está funcionando.
- No lleve ropa suelta ni que cuelgue mientras utiliza la cinta andadora.
- No debe utilizarse en exteriores.
- No tense demasiado la cinta móvil.
- No utilice este tapiz rodante si tiene el cable o el enchufe dañados, si no funciona adecuadamente o si ha sufrido algún golpe o deterioro. Póngase en contacto con su vendedor autorizado de **STAR TRAC**, con el departamento de servicios de **STAR TRAC** llamando al número +1 714 669 1660 o accediendo a nuestra página de la web en <http://www.startrac.com>, para un examen o reparación inmediatos.
- No utilice el tapiz rodante sin calzado deportivo.
- No deje caer ni introduzca ningún objeto, manos o pies en ninguna abertura del aparato o debajo del mismo.
- No deje botellas de agua ni tazas sobre su tapiz rodante excepto si utiliza el accesorio adicional diseñado para este fin. No utilice su tapiz rodante en lugares en los que se están usando productos aerosoles (en spray) o en los que se está administrando oxígeno.
- No encienda este aparato con la cubierta del motor retirada, ni lo modifique de ninguna manera.

SIKKERHEDSINSTRUKTIONER



FORSIGTIG: AFBRYD EL-KABLET, FØR DU GØR RENT ELLER SERVICERER.

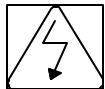

FORSIGTIG: LÆS INSTRUKTIONSHÅNDBOGEN FØR BRUG.

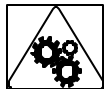

FORSIGTIG: RÖRLIGA DELAR – LÅT INGA HÄNDER ELLER FÖTTER BEFINNA SIG UNDER LÖPBANDET NÄR DET ÄR IGÅNG.



STOP (AF FUNKTION)



TÆND

SLUK

ADVARSEL

Dette produkt er beregnet til brug i forbindelse med et el-net med nominal effekt på 220 volt. Det leveres med særlig ledning og stik fra fabrikken, som kun passer til den korrekte type el-net. Sørg for, at produktet er sat til en stikkontakt, som har samme konfiguration som stikket. DER MÅ IKKE BRUGES ADAPTER TIL DETTE PRODUKT. Hvis produktet absolut skal omstilles til en anden slags el-net, skal omstillingen foretages af kvalificeret servicepersonale.

Disse sikkerhedsbemærkninger henvendes til ejeren af **STAR TRAC S-TRÆDEMØLLEN**. Sørg venligst for, at alle medlemmer og alt kondipersonale kender og følger disse sikkerhedsregler.

LÆS ALLE INSTRUKTIONERNE, FØR DU BRUGER DIN TRÆDEMØLLE.

ADVARSEL: For at mindske risikoen for at få elektrisk stød, skal du **ALTID** trække trædemøllens stik ud af kontakten, før du gør den ren.

Skal

- Stig af trædemøllen, hvis du bliver mat i kroppen eller svimmel.
- Kend dine begrænsninger.
- Håll løpbandets yta torr och ren.
- Træk trædemøllens stik ud af kontakten, før du gør den ren, eller fjerner eller udskifter en del.
- Brug kun produktet til det formål, det er beregnet til.
- Foretag forebyggende vedligeholdelse med regelmæssige mellemrum.
- Tänk på placeringen av löpbandet samt att du endast använder nödknappen Stop när det är nödvändigt.
- Holdledningen fri af varmeanlæg.
- Vent til løbebåndet standser, før du stiger af trædemøllen.
- Hold ventilationsåbningerne fri for fnug, hår og lignende. Brug aldrig trædemøllen med blokerede luftventilationsåbninger.
- Sluk for elektriciteten på afbryderkontakten.

Må Ikke

- Tillad ikke børn uden opsyn at bruge trædemøllen.
- Stig ikke på eller af trædemøllen, mens den kører.
- Bär inga löst hängande kläder som kan fastna när du använder löpbandet.
- Brug ikke trædemøllen udendørs.
- Stram ikke løbebåndet for meget.
- Brug ikke trædemøllen, hvis ledningen eller stikket er beskadiget, hvis trædemøllen ikke fungerer rigtigt, eller hvis den er faldet ned eller væltet og er blevet beskadiget. Kontakt den autoreserede STAR TRAC, forhandler eller serviceafdelingen hos STAR TRAC Ring på +1 71 46 69 1660 eller du kan få fat i os på vores web-site: <http://www.startrac.com> for øjeblikkeligt eftersyn eller reparation.
- Brug ikke trædemøllen uden kondisko.
- Undgå at tabe eller at stikke genstande, hænder eller fødder ind i en åbning i eller under udstyret.
- Stil ikke vandflasker eller kopper på trædemøllen, medmindre du har dertil beregnet tilbehør, som er specielt designet til trædemøllen. Brug ikke trædemøllen på steder, hvor der bruges aerosolprodukter (spray), eller hvor der administreres ilt.
- Udstyret må ikke køre uden motorafskærmning, og det er ikke tilladt at ændre udstyret på nogen måde.

ASSEMBLY AND SETUP

Use the following procedures to unpack and assemble your **STAR TRAC S SERIES TREADMILL**. Assembly procedures are the same for all **S SERIES TREADMILLS**.

UNPACKING

Open the shipping carton, remove all parts from the carton and foam inserts, and verify that the following parts are included in your shipment:

Description	Qty	Description	Qty
Base Assembly	1	Lockwasher, D=10	8
Neck (and Shroud)	1	Hex Nuts*	4
Neck Shroud	1	Bolt, Allen Head, M6 X 50	4
Display Console Assembly	1	Screw, Hex Head, M10 X 140**	4
Handrail	2	Bolt, Allen Head, M6 X 25	2
Bolt, Allen Head, M10 X 20	8	Lockwasher, D=6	4

*Used for shipping only.

**Pre-installed on base assembly.

TOOLS REQUIRED

Most **STAR TRAC** treadmills can be assembled using the following tools:

- Metric Hex Key Wrenches
- Metric Open-End Wrenches
- Metric Ratchet Socket Wrench Set
- Torque Wrench
- Channel Lock Pliers
- Vice Grip Pliers
- Rubber Mallet
- Phillips Head Screwdriver

Your **STAR TRAC S SERIES TREADMILL** includes a hex key set and combination open-end wrench.

ASSEMBLY

1. Unpack and Position the Base Assembly

CAUTION: The motor end of the base assembly is very heavy. Two people may be needed to lift this end when moving the base assembly.

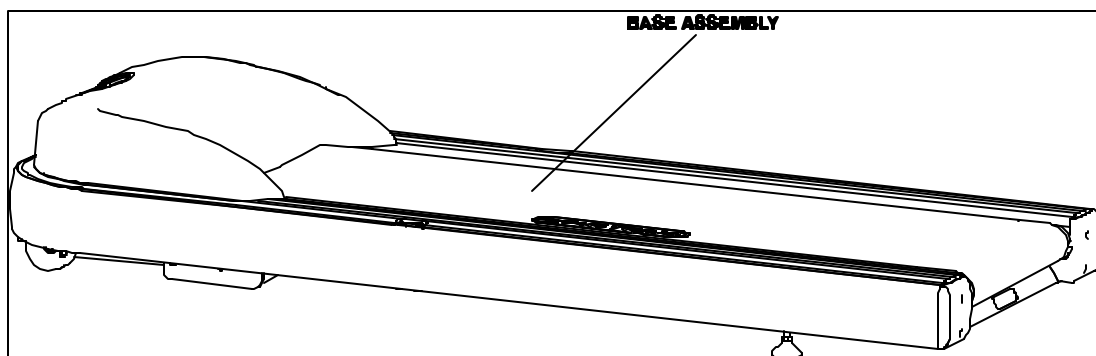

Remove all packaging material so the base assembly is sitting on the shipping crate platform. With a helper, lift the base assembly from the shipping crate platform, and place it in the location where it will be used. Be sure the selected location is level, and close to a power outlet.

3. Install the Display Console

CAUTION: To ensure proper routing of display cables, have one person hold and position the display console while a second person feeds the display cable through the treadmill neck.

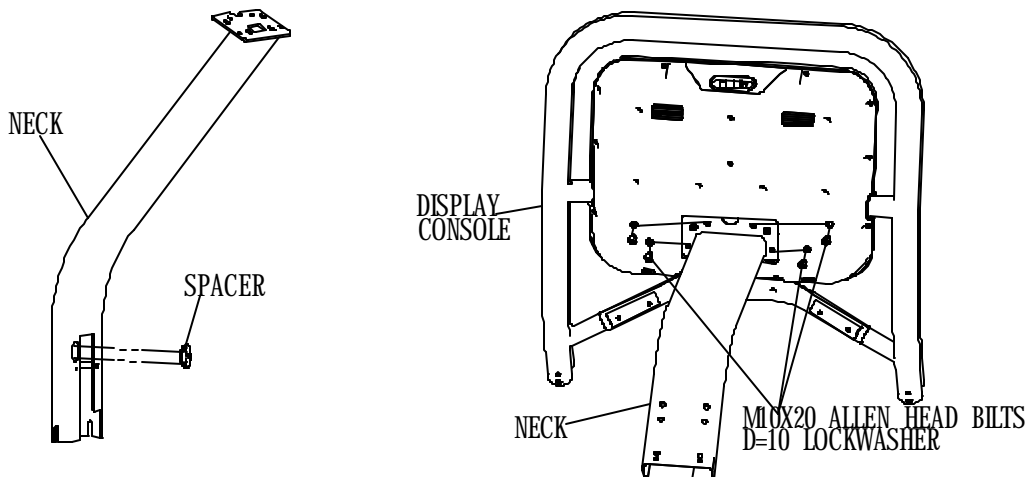

Remove the cover from the power cord access hole in the treadmill neck. If not preassembled, slide the neck shroud onto the treadmill neck.

With one person supporting the display console, carefully feed the display cable into the neck. Reposition the display console as needed during this step to ensure the display cable does not bunch or kink in the neck. Ensure the display cable feeds completely through the neck and out the power cord access hole.

Position the display console on the neck, taking care not to pinch the display cable between the neck and the console. Once the console is properly positioned, secure the console to the neck using four M10 X 20 Allen head bolts and D=10 lockwashers. Tighten the screws securely

3. Install the Neck

Position the neck in place on the motor end of the base assembly, and secure with four M10 X 20 Allen bolts and D=10 lockwashers. Tighten the screws securely.

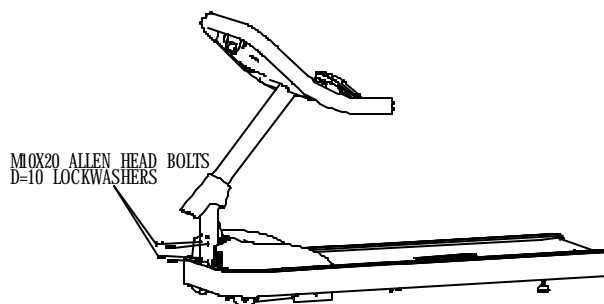

Slide the neck shroud down into position on the base assembly shroud to cover the display cable.

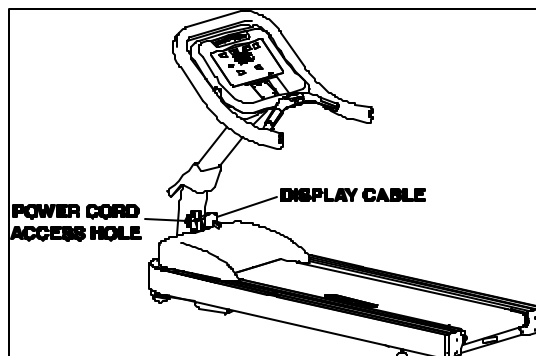

4. Install the Handrails

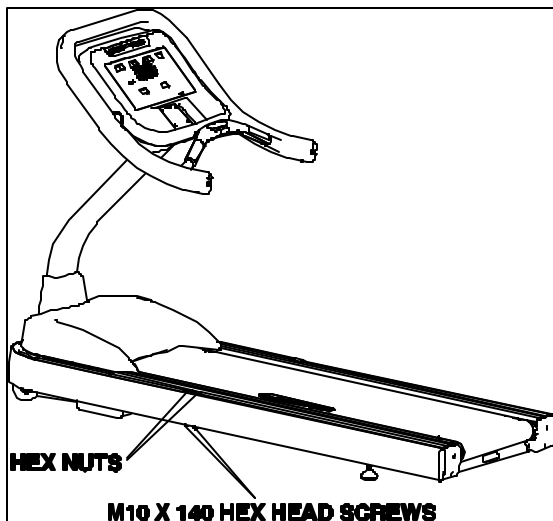

NOTE: Both handrails are installed in a similar manner.

Remove the four M10 X 140 hex head screws and hex nuts from the base assembly. Discard the hex nuts.

Insert the connecting tube of the handrail into the handrail stub in the display console. Slide the handrail fully into the console.

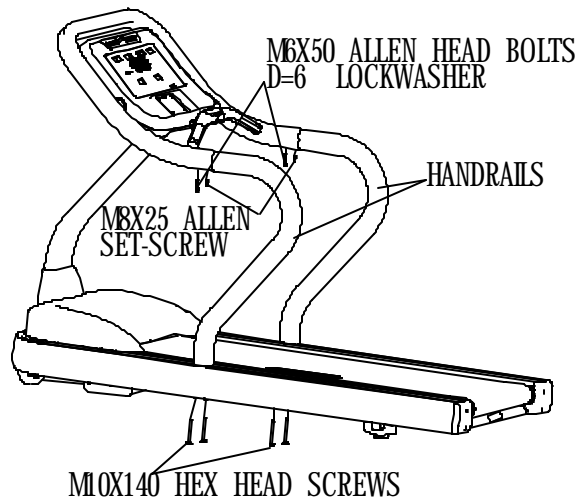

If necessary, rotate the handrail slightly to align the display console handrail stub with the threaded hole in the handrail connecting tube. Secure the handrail to the display console with two M6 X 50 Allen head bolts and D=6 lockwashers two M8 X 25 Allen Set-Screw. Secure the handrail to the treadmill base assembly with two M10 X 140 hex head screws. Tighten all screws securely.

Install the remaining handrail in a similar manner.

5. Connect the Display Cable

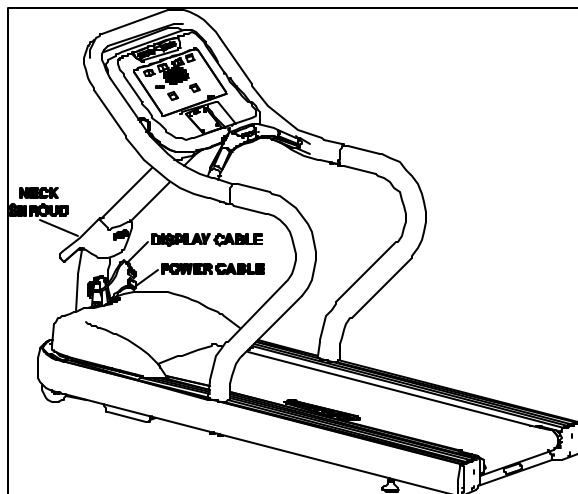

Slide the neck shroud up to gain access to the display cable. Connect the display cable to the base assembly power cord.

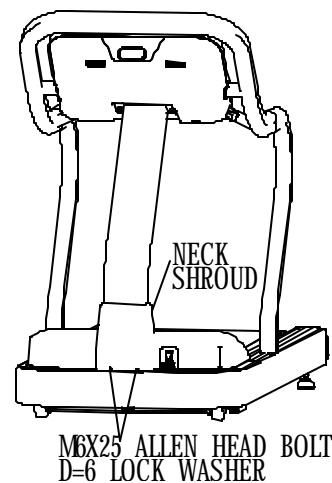

Slide the neck shroud down into position on the base assembly shroud. Secure the neck shroud to the base assembly using two M6 X 25 Allen head bolts and D=6 lockwashers.

6. Final Assembly

Check the security of all hardware installed during assembly, and tighten as necessary.

If necessary, level the treadmill using the two adjustable feet under the tailroller (at the rear of the base assembly). Loosen the locknuts, rotate the feet until the treadmill is stabilized, then retighten the locknuts.

You have now completed assembly of your **STAR TRAC S SERIES TREADMILL**.

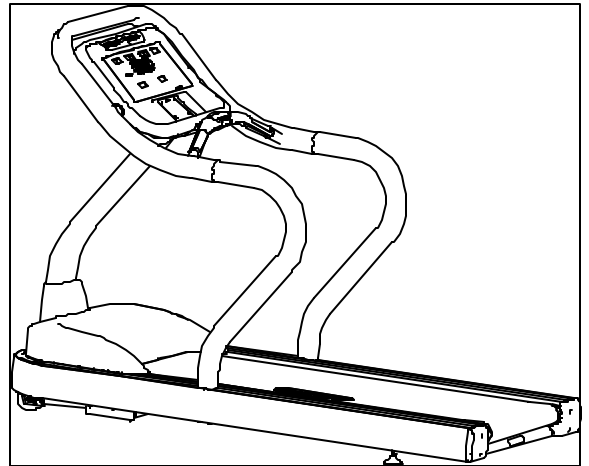

ATTENTION

- Star Trac recommends that treadmills be spaced a minimum of 20 inches (0.5 m) apart to allow safe and easy ingress and egress. More importantly, there must be at least 48 inches (1.5 m) of free space behind the treadmills.
- As with other motorized equipment, the area where the treadmill is located must be free of obstacles and fixtures with sharp edges to prevent injury in the event that a user trips or loses balance and falls.
- DO NOT place treadmill near wet areas (such as pools, showers etc.).

OPERATING INSTRUCTIONS

Operating the **STAR TRAC S SERIES TREADMILL** is very easy. Simply step onto the running belt, press **QUICK START**, and begin walking or running naturally. Learning the features and incorporating the **STAR TRAC S SERIES TREADMILL** into your members' fitness programs is just as easy. In this chapter, you will learn the display functions and how to get the most out of every **STAR TRAC S SERIES TREADMILL** workout.

DISPLAY PANEL FEATURES

Your **STAR TRAC S SERIES TREADMILL** is equipped to provide you and your users unlimited exercise opportunities. Experiment with its features to find the right combination for your fitness regimen. The Display panel provides the operating controls and display elements described in the following paragraphs. Display Panel layout and arrangement varies slightly between models (as shown below). Each Display Panel provides the operating controls and display elements described in the following paragraphs.

Model S-TRc Treadmill

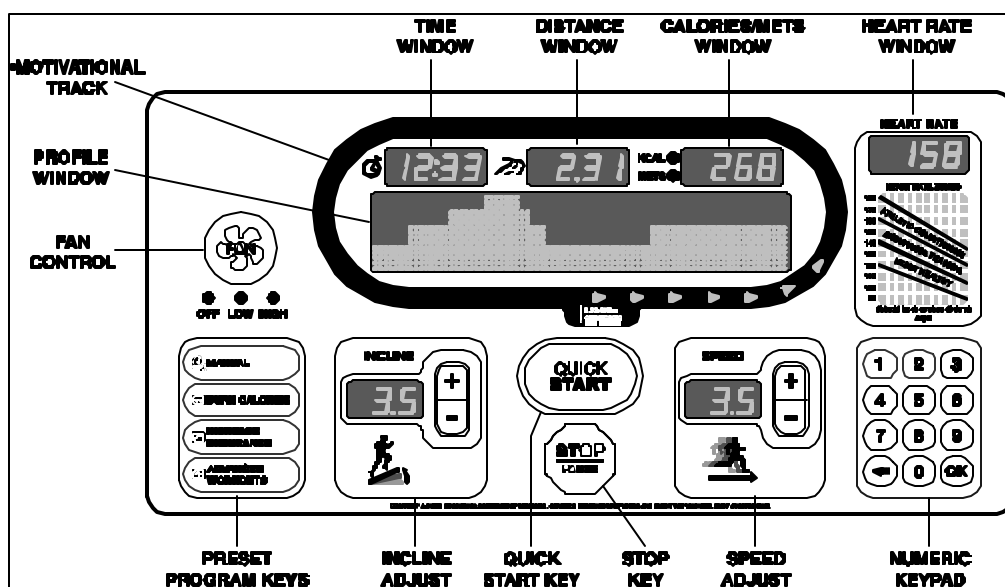

Model S-TRx and S-TR Treadmills

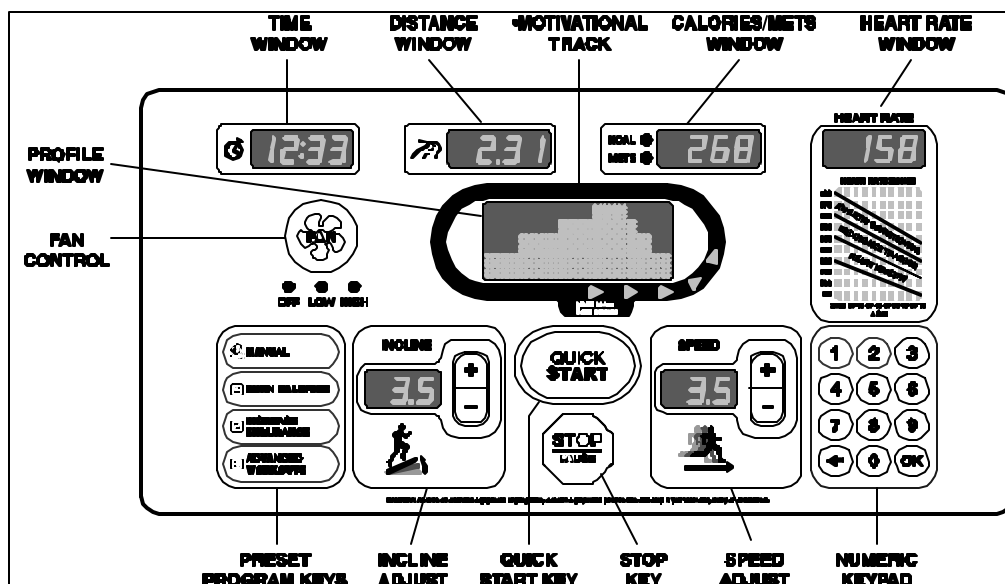



QUICK START Key: Starts the treadmill running belt moving using a default weight of 155 pounds and a default time limit of 99 minutes.

NOTE: Default time and weight are adjustable through Manager/Maintenance mode.



STOP / PAUSE Key: Pauses the treadmill when pressed once. Ends the current program when pressed twice.



Numeric Keypad: Allows you to enter specific values for program parameters during program setup. During a program, these keys may be used to change resistance level.



OK Key: (part of numeric keypad) Allows you to confirm selections during program setup and operation.



Arrow Key: (part of numeric keypad) Allows you to make corrections to values entered during program setup.

SPEED Keys / Window: Adjust running belt speed in 0.1 mph (or 0.1 kph) increments. To increase or decrease speed, press the or keys, respectively, until the desired speed appears in the window, then press the key. Speed cannot be higher than the established MX SPD parameter (see “Manager / Maintenance Settings” for details.) These keys repeat when pressed and held. The SPEED window shows the speed at which you are walking/running, from 0.5 mph (0.8 kph) to 12.5 mph (20.0 kph).



INCLINE Keys / Window: Adjust incline in 0.5% increments. To increase or decrease incline, press the or keys, respectively, until the desired incline appears in the window, then press the key. Incline cannot be higher than the established ELM parameter (see “Manager / Maintenance Settings” for details.) These keys repeat when pressed and held. The INCLINE window shows the incline at which you are walking/running, from 0.0% to 15.0%.



FAN Key: Allows you to control the speed of the personal cooling fan, either OFF, LOW or HIGH.

Preset Program Keys: Allow you to access a desired preset workout program.

TIME Window: Shows the duration of your workout thus far in minutes and seconds.

DISTANCE Window: Shows the total number of miles or kilometers you have traveled thus far.

CALORIES / METS WINDOW: Alternates, display of your aggregate caloric expenditure (displays for six seconds) and instantaneous METS expenditure (displays for three seconds) in your workout.

HEART RATE Window: Shows your current rate in beats-per-minute (BPM) while wearing the heart rate strap or grasping the heart rate grips.

Profile Display: Traces your progress through each of the programs and allows you to anticipate changes in terrain. Display elements illuminate from left to right across the bottom of the display to indicate your progress through the course. At each step, display elements illuminate in columns to indicate your ascent up the gradient that is in effect. Provides informational messages, prompts during program setup, feedback during your workout, and notification when your workout is complete.

Motivational Track: Shows your progress counter clockwise around 1/4-mile (400-meter) course, starting from the bottom center.

At the conclusion of your workout, the TIME Window, DISTANCE Window, CALORIES / METS Window and HEART RATE Window show your summarized workout data. Workout Data includes:

- Elapsed time since program began
- Accumulated calories / average METS expended
- Distance traveled – miles or kilometers
- Average heart rate

HINTS AND TIPS FOR GETTING STARTED







The following hints and tips will assist in training your users to maximize the fitness benefits of your **STAR TRAC S SERIES TREADMILL**.

- **Walk or run at a rate that feels comfortable and most natural, yet is sufficiently vigorous to get a good cardio workout.**
- **Try different walking or running rhythms.** In manual operation, adjust your pace from low speed to high speed, then back to low. As you become more comfortable with your treadmill, try going faster or using the preset programs.
- **Watch the Graphic Display to anticipate terrain changes.** When you use the preset programs, the display shows changes in terrain as tall or short columns.

COOLDOWN CYCLE

In most programs, once you have completed your workout, the treadmill enters a two-minute Cooldown cycle.

To operate the treadmill during Cooldown:

1. You can adjust the incline of the treadmill during Cooldown.
 - You can adjust treadmill **incline** from 0 to 15%, in 0.5% increments. Press the  key to increase the treadmill incline; press the  key to decrease the treadmill incline.
2. You can adjust the speed of the treadmill during Cooldown.
 - You can specify a desired speed from 0.5 to 12.5 mph (0.8 to 20.0 kph) using the numeric keypad. Use the  keys to enter your desired speed, then press the  key to accept the entered speed.
 - You can adjust treadmill speed from 0.5 to 12.5 mph (0.8 to 20.0 kph), in 0.1 mph (or 0.1 kph) increments. Press the  key to increase the treadmill speed; press the  key to decrease the treadmill speed.
3. When the Cooldown cycle ends, your workout summary displays in the information windows. If you wish to exit the Cooldown cycle before it ends automatically, Press the press the STOP key twice.

USING THE PERSONAL FANS

The **STAR TRAC S SERIES TREADMILL** is equipped with built-in personal fans to increase your comfort during a workout. The fans will automatically start one minute after you begin your workout. You can control the fan speed during your workout.

NOTE: The automatic fan function can be enabled/disabled through Manager/Maintenance mode.

To operate the personal fans:

- Press the  key, as necessary, to cycle the personal fans from OFF to LOW to HIGH to OFF. An LED indicator lights to show the currently selected fan speed.
- The fans remains set at the set speed if you pause your program.
- The fans turn off automatically if you exit your workout, or when you complete your workout program.

HEART RATE MONITORING

Heart rate monitoring allows you to determine if your workout is too challenging or not challenging enough. Monitoring heart rate is easy with the **STAR TRAC S SERIES TREADMILL**. You may use a heart rate strap (not provided with the treadmill), or you can simply grasp the silver contact heart rate grips.

NOTE: The Heart Rate monitor is not a medical test, nor is it designed as a medical test. It is simply a guide to target heart rate training. Please consult with your physician prior to engaging in any strenuous physical activity.

IMPORTANT: The manufacturer does not warrant the heart rate system **performance** on this product, as the heart rate system performance varies, based on a user's physiology, fitness level, age, method of use and other factors. Furthermore, the heart rate system is not for medical use.

CONTACT HEART RATE MONITORING

You may use the heart rate contact grips to automatically check your heart rate. Just follow these steps.

1. Grasp the stainless steel heart rate contact grips; you do not have to squeeze tightly.
2. It may take from 30 to 60 seconds for the heart rate system to acquire and display your heart rate. While your heart rate is acquired, a pulsing heart  displays in the Profile Window.
3. Once your heart rate has been acquired, the Profile Window returns to its normal display mode, and your current heart rate in beats-per-minute (BPM) displays in the HEART RATE Window.
4. Release the Heart Rate grips if you wish to remove your heart rate reading from the display.

CHEST STRAP HEART RATE MONITORING

You may use the heart rate strap to automatically check your heart rate. Just follow these steps:



1. Before beginning your workout, or during a pause, moisten the back of the transmitter on the heart rate strap (not included). Place the strap snugly around your chest with the transmitter resting directly over your sternum.
2. When your heart rate has been acquired, your heart rate in beats-per-minute (BPM) displays in the HEART RATE Window.
3. Remove the heart rate strap, if you wish to remove your heart rate reading from the display.

NOTE: The performance of the transmitter may be affected by body types, body oils, metal in clothing, and outside electrical interference. Always be sure that the transmitter and skin are in good contact. Avoid operating other electrical equipment near your treadmill when you use the heart rate strap.

LOCKOUT ID PROCESSING

When the Lockout Enable has been set in Manage / Maintenance Mode (see “Manager Mode” or “Maintenance Mode”, as appropriate), users must enter a Lockout ID number to enable the treadmill for operation.

To enter a Lockout ID:

1. Stand on the running belt and press the desired program key.
 - If Lockout Enable is set, the message “TREADMILL LOCKED; PRESS 0 TO ENTER ID” scrolls across the Profile Window.
2. Press the  key, then use the  keys to enter the three-digit Lockout ID. Entered digits will show in the Profile Window.
3. When the Lockout ID has been entered, press the  key.
 - If you enter the correct Lockout ID, the message “VALID ID” scrolls once across the Profile Window. You may continue with normal operation of the bike (see “Quick Start” or “Preset Programs”, as desired).
 - If you enter an incorrect Lockout ID, the message “INVALID ID” scrolls once across the Profile Window. Make sure you have the correct Lockout ID, then repeat steps 1 through 3 to re-enter.







QUICK START

QUICK START lets you begin your workout by simply pressing one key. QUICK START uses a default weight of 155 pounds (70 kg) and a time limit of 99 minutes. YOU control the treadmill speed, incline and distance for up to the maximum allowed program time.

NOTE: The default time and weight are adjustable through Manager / Maintenance Mode.

To operate the QUICK START program:





1. Stand on the running belt and press the QUICK START key. The running belt slowly accelerates to its minimum speed as defined in Manager / Maintenance Mode.
 - If necessary, enter the Lockout ID to enable the treadmill for operation (see “Lockout ID Processing”).
2. If desired, you can use the personal fans during your workout (see “Using the Personal Fans” for details).

3. You can adjust the incline of the treadmill during the program:
 - You can adjust treadmill incline from 0 to 15%, in 0.5% increments. Press the  key to increase the treadmill incline; press the  key to decrease the treadmill incline.
4. You can adjust the speed of the treadmill during the program:
 - You can specify a desired speed from 0.5 to 12.5 mph (0.8 to 20.0 kph) using the numeric keypad. Use the  keys to enter your desired speed, then press the  key to accept the entered speed.
 - You can adjust treadmill speed from 0.5 to 12.5 mph (0.8 to 20.0 kph), in 0.1 mph (or 0.1 kph) increments. Press the  key to increase the treadmill speed; press the  key to decrease the treadmill speed.
5. You can pause the program during your workout by pressing the STOP key once. The program will pause for a preset period of time (30, 45, 60, 90 or 120 seconds, as set in Manager/Maintenance mode). Press the START key BEFORE the pause timer expires to resume your program. The treadmill returns to its minimum speed when you exit the pause mode.
6. When you have reached your workout goal, the treadmill enters the Cooldown cycle (see “Cooldown Cycle” for details). If you wish to exit the program before you have reached your workout goal, press the STOP key twice. The treadmill will slow to a stop. (Press the STOP key once during a Pause to exit the program.).

PRESET PROGRAMS

The **STAR TRAC S-SERIES TREADMILLS** offer up to 12 preset programs to add variety and challenge to your workout, including the **ADVANCED WORKOUTS** function that provides three cardio-intensive training programs, **FITNESS TESTS** and individual **GOAL WORKOUTS**. **PLEASE NOTE:** Some programs are not available on all treadmill models. Program applicability is noted where appropriate.









Pre-set programs include:









-  Allows the user to pre-program a time goal and user weight. Treadmill speed and incline are determined by the user during the program.
-  An intense 3-peak run that allows the user to pre-program a time goal, user weight and maximum speed and incline
-  Allows the user to pre-program a time goal, user weight and maximum speed and incline. The program begins at a speed of 0.5 mph (0.8 kph) and an incline of 0%, then increases linearly to the specified maximum levels.
-  Our **ADVANCED WORKOUTS** programs offer the user the ability to train in specific HR zones, to complete a **FITNESS TEST** or **FIREFIGHTER FITNESS TEST**, or to utilize other goal-oriented programs.

MANUAL PROGRAM

The **MANUAL** program allows the user to pre-program a time goal and user weight. Treadmill speed and incline are determined by the user during the program.

To operate the **MANUAL** program:

















1. Stand on the running belt and press the  key.
 - If necessary, enter the Lockout ID to enable the bike for operation (see “Lockout ID Processing” for details).
2. You are prompted to enter your weight. The treadmill displays a default weight of 155 pounds (70 kg). You may enter any weight from 0 to 500 pounds (0 to 226 kg).
 - Use the  keys to enter your current weight; or press the  or  key, as necessary, to increase or decrease the displayed weight in 1 pound (or 1 kg) increments.
 - When your correct weight has been entered, press the  key to accept the displayed value.
3. You are prompted to enter a time goal. The default time is 99 minutes. You may enter any time from 1 to 99 minutes.
 - Use the  keys to enter your desired time goal; or press the  or  key, as necessary, to increase or decrease the displayed value in 1 minute increments.
 - When your desired goal has been entered, press the  key to accept the displayed value.









4. You are prompted with a 3-second countdown, then the treadmill begins the program.
5. If desired, you can use the personal fans during your workout (see “Using the Personal Fans” for details).
6. You can adjust the incline of the treadmill during the program:
 - You can adjust treadmill incline from 0 to 15%, in 0.5% increments. Press the  key to increase the treadmill incline; press the  key to decrease the treadmill incline.
7. You can adjust the speed of the treadmill during the program:
 - You can specify a desired speed from 0.5 to 12.5 mph (0.8 to 20.0 kph) using the numeric keypad. Use the  keys to enter your desired speed, then press the  key to accept the entered speed.
 - You can adjust treadmill speed from 0.5 to 12.5 mph (0.8 to 20.0 kph), in 0.1 mph (or 0.1 kph) increments. Press the  key to increase the treadmill speed; press the  key to decrease the treadmill speed.
8. You can pause the program during your workout by pressing the STOP key once. The program will pause for a preset period of time (30, 45, 60, 90 or 120 seconds, as set in Manager/Maintenance mode). Press the START key BEFORE the pause timer expires to resume your program. The treadmill returns to its minimum speed when you exit the pause mode.
9. If desired, you can jump to another preset program if your remaining workout time is greater than 5 minutes.
 - To jump to another preset program, press the  or  key, as desired.
10. When you have reached your workout goal, the treadmill enters the Cooldown cycle (see “Cooldown Cycle” for details). If you wish to exit the program before you have reached your workout goal, press the STOP key twice. The treadmill will slow to a stop. (Press the STOP key once during a Pause to exit the program.).

BURN CALORIES PROGRAM

The BURN CALORIES program provides an intense 3-peak run that allows the user to pre-program a time goal, user weight and maximum speed and incline.

To operate the BURN CALORIES program:

















1. Stand on the running belt and press the  key.
 - If necessary, enter the Lockout ID to enable the bike for operation (see “Lockout ID Processing” for details).
2. You are prompted to enter your weight. The treadmill displays a default weight of 155 pounds (70 kg). You may enter any weight from 0 to 500 pounds (0 to 226 kg).
 - Use the  keys to enter your current weight; or press the  or  key, as necessary, to increase or decrease the displayed weight in 1 pound (or 1 kg) increments.
 - When your correct weight has been entered, press the  key to accept the displayed value.
3. You are prompted to enter a time goal. The default time is 99 minutes. You may enter any time from 1 to 99 minutes.
 - Use the  keys to enter your desired time goal; or press the  or  key, as necessary, to increase or decrease the displayed value in 1 minute increments.
 - When your desired goal has been entered, press the  key to accept the displayed value.
4. You are prompted to enter a maximum speed. You can specify a desired speed from 0.5 to 12.5 mph (0.8 to 20.0 kph).
 - Use the  keys to enter the desired maximum speed; or press the  or  key, as necessary, to increase or decrease the maximum speed in 0.1 unit increments.
 - When the desired maximum speed has been entered, press the  key to accept the displayed value.
5. You are prompted to enter a maximum incline. You may enter any incline from 0.0% to 15.0%.
 - Use the  keys to enter the desired maximum incline; or press the  or  key, as necessary, to increase or decrease the maximum incline in 0.5% increments.
 - When the desired maximum incline has been entered, press the  key to accept the displayed value.
6. You are prompted with a 3-second countdown, then the treadmill begins the program.









7. If desired, you can use the personal fans during your workout (see “Using the Personal Fans” for details).
8. You can adjust the incline of the treadmill during the program:
 - You can adjust treadmill incline from 0 to 15%, in 0.5% increments. Press the  key to increase the treadmill incline; press the  key to decrease the treadmill incline.
9. You can adjust the speed of the treadmill during the program:
 - You can specify a desired speed from 0.5 to 12.5 mph (0.8 to 20.0 kph) using the numeric keypad. Use the  keys to enter your desired speed, then press the  key to accept the entered speed.
 - You can adjust treadmill speed from 0.5 to 12.5 mph (0.8 to 20.0 kph), in 0.1 mph (or 0.1 kph) increments. Press the  key to increase the treadmill speed; press the  key to decrease the treadmill speed.
10. You can pause the program during your workout by pressing the STOP key once. The program will pause for a preset period of time (30, 45, 60, 90 or 120 seconds, as set in Manager/Maintenance mode). Press the START key BEFORE the pause timer expires to resume your program. The treadmill returns to its minimum speed when you exit the pause mode.
11. If desired, you can jump to another preset program if your remaining workout time is greater than 5 minutes.
 - To jump to another preset program, press the  or  key, as desired.
12. When you have reached your workout goal, the treadmill enters the Cooldown cycle (see “Cooldown Cycle” for details). If you wish to exit the program before you have reached your workout goal, press the STOP key twice. The treadmill will slow to a stop. (Press the STOP key once during a Pause to exit the program.).

INCREASE ENDURANCE PROGRAM

The INCREASE ENDURANCE program allows the user to pre-program a time goal, user weight and maximum speed and incline. The program begins at a speed of 0.5 mph (0.8 kph) and an incline of 0%, then increases linearly to the specified maximum levels.

To operate the INCREASE ENDURANCE program:

1. Stand on the running belt and press the  key.
 - If necessary, enter the Lockout ID to enable the bike for operation (see “Lockout ID Processing” for details).
2. You are prompted to enter your weight. The treadmill displays a default weight of 155 pounds (70 kg). You may enter any weight from 0 to 500 pounds (0 to 226 kg).
 - Use the  keys to enter your current weight; or press the  or  key, as necessary, to increase or decrease the displayed weight in 1 pound (or 1 kg) increments.
 - When your correct weight has been entered, press the  key to accept the displayed value.
3. You are prompted to enter a time goal. The default time is 99 minutes. You may enter any time from 1 to 99 minutes.
 - Use the  keys to enter your desired time goal; or press the  or  key, as necessary, to increase or decrease the displayed value in 1 minute increments.
 - When your desired goal has been entered, press the  key to accept the displayed value.
4. You are prompted to enter a maximum speed. You can specify a desired speed from 0.5 to 12.5 mph (0.8 to 20.0 kph).
 - Use the  keys to enter the desired maximum speed; or press the  or  key, as necessary, to increase or decrease the maximum speed in 0.1 unit increments.
 - When the desired maximum speed has been entered, press the  key to accept the displayed value.
5. You are prompted to enter a maximum incline. You may enter any incline from 0.0% to 15.0%.
 - Use the  keys to enter the desired maximum incline; or press the  or  key, as necessary, to increase or decrease the maximum incline in 0.5% increments.
 - When the desired maximum incline has been entered, press the  key to accept the displayed value.
6. You are prompted with a 3-second countdown, then the treadmill begins the program.
7. If desired, you can use the personal fans during your workout (see “Using the Personal Fans” for details).

8. You can adjust the incline of the treadmill during the program:
 - You can adjust treadmill incline from 0 to 15%, in 0.5% increments. Press the  key to increase the treadmill incline; press the  key to decrease the treadmill incline.
9. You can adjust the speed of the treadmill during the program:
 - You can specify a desired speed from 0.5 to 12.5 mph (0.8 to 20.0 kph) using the numeric keypad. Use the  keys to enter your desired speed, then press the  key to accept the entered speed.
 - You can adjust treadmill speed from 0.5 to 12.5 mph (0.8 to 20.0 kph), in 0.1 mph (or 0.1 kph) increments. Press the  key to increase the treadmill speed; press the  key to decrease the treadmill speed.
10. You can pause the program during your workout by pressing the STOP key once. The program will pause for a preset period of time (30, 45, 60, 90 or 120 seconds, as set in Manager/Maintenance mode). Press the START key BEFORE the pause timer expires to resume your program. The treadmill returns to its minimum speed when you exit the pause mode.
11. If desired, you can jump to another preset program if your remaining workout time is greater than 5 minutes.
 - To jump to another preset program, press the  or  key, as desired.
12. When you have reached your workout goal, the treadmill enters the Cooldown cycle (see “Cooldown Cycle” for details). If you wish to exit the program before you have reached your workout goal, press the STOP key twice. The treadmill will slow to a stop. (Press the STOP key once during a Pause to exit the program.).

ADVANCED WORKOUTS PROGRAMS

The ADVANCED WORKOUTS programs include the HEART RATE TRAINING and BURN FAT programs, the FITNESS TEST programs and GOAL WORKOUTS programs. When using the HEART RATE TRAINING programs, use of the heart rate strap (rather than the heart rate grips) is recommended.















HEART RATE CONTROL PROGRAMS









ADVANCED WORKOUTS offers both a DYNAMIC HEART RATE CONTROL program and a CONSTANT HEART RATE CONTROL program, as well as the BURN FAT program.

NOTE: For best results, use a heart rate strap. If user is wearing a heart rate strap, the treadmill will automatically use the data from the heart rate strap.

To operate the Constant Heart Rate Control program:

This heart rate feature is designed to maintain your heart rate at a constant level by varying treadmill speed and incline. Please note that your heart rate may vary above and below your target heart rate during this program.

1. Stand on the running belt and press the  key.
 - If necessary, enter the Lockout ID to enable the bike for operation (see “Lockout ID Processing” for details).
2. You are prompted to select the desired ADVANCED WORKOUTS program. Press the  key to select the HEART RATE TRAINING programs, then press the  key when prompted to select CONSTANT HEART RATE CONTROL.
3. You are prompted to enter your weight. The treadmill displays a default weight of 155 pounds (70 kg). You may enter any weight from 0 to 500 pounds (0 to 226 kg).
 - Use the  keys to enter your current weight; or press the  or  key, as necessary, to increase or decrease the displayed weight in 1 pound (or 1 kg) increments.
 - When your correct weight has been entered, press the  key to accept the displayed value.
4. You are prompted to enter a time goal. The treadmill displays a default time of 99 minutes. You may enter any time from 1 to 99 minutes.
 - Use the  keys to enter your desired time goal; or press the  or  key, as necessary, to increase or decrease the displayed value in 1 minute increments.
 - When your desired goal has been entered, press the  key to accept the displayed value.
5. You are prompted to enter your age.
 - Use the  keys to enter your age, or press the  or  key, as necessary, to increase or decrease the displayed value in 1 year increments.











- When your correct age has been entered, press the  key to accept the displayed value.
- You are prompted to enter a target heart rate. The treadmill displays a default target heart rate that is based on 70% of your theoretical maximum heart rate (220 BPM - age). You may enter any value from 70 to 200 BPM.
 - Use the  keys to enter your target heart rate, or press the  or  key, as desired, to increase or decrease the target heart rate in 1 BPM increments.
 - When the desired target heart rate has been entered, press the  key to accept the displayed value.
 - You are prompted to enter a maximum speed. You can specify a desired speed from 0.5 to 12.5 mph (0.8 to 20.0 kph).
 - Use the  keys to enter the desired maximum speed; or press the  or  key, as necessary, to increase or decrease the maximum speed in 0.1 unit increments.
 - When the desired maximum speed has been entered, press the  key to accept the displayed value.
 - You are prompted with a 3-second countdown, then the treadmill begins the program.
 - If desired, you can use the personal fans during your workout (see “Using the Personal Fans” for details).
 - You can pause the program during your workout by pressing the STOP key once. The program will pause for a preset period of time (30, 45, 60, 90 or 120 seconds, as set in Manager/Maintenance mode). Press the START key BEFORE the pause timer expires to resume your program. The treadmill returns to its minimum speed when you exit the pause mode.
 - When you have reached your workout goal, the treadmill enters the Cooldown cycle (see “Cooldown Cycle” for details). If you wish to exit the program before you have reached your workout goal, press the STOP key twice. The treadmill will slow to a stop. (Press the STOP key once during a Pause to exit the program.)

To operate the DYNAMIC HEART RATE CONTROL program:

This heart rate feature is designed to gradually elevate your heart rate to the upper end of your selected training range, then gradually decrease your heart rate to the lower end of your selected training range by varying treadmill speed and incline. During the workout, this cycle will repeat several times until the time goal is complete, creating an interval training effect that is customized to the user’s desired heart rate training range.

During program setup, there must be at least an 18 BPM difference between the lower heart rate limit and upper heart rate limit to ensure an interval workout.

By including interval exercise in your regular aerobic program, greater effects are noticed. Your heart and muscles will adapt to the increases in demand by utilizing stored calories for energy more effectively. Dynamic Heart Rate Control may potentially result in more calories expended. It will strengthen the heart, provide stress relief and variety to a workout. This program is more effective in training the body to remove excess lactic acid from the muscles.

- Stand on the running belt and press the  key.
 - If necessary, enter the Lockout ID to enable the bike for operation (see “Lockout ID Processing” for details).
- You are prompted to select the desired ADVANCED WORKOUTS program. Press the  key to select the HEART RATE TRAINING programs, then press the  key when prompted to select DYNAMIC HEART RATE CONTROL.
- You are prompted to enter your weight. The treadmill displays a default weight of 155 pounds (70 kg). You may enter any weight from 0 to 500 pounds (0 to 226 kg).
 - Use the  keys to enter your current weight; or press the  or  key, as necessary, to increase or decrease the displayed weight in 1 pound (or 1 kg) increments.
 - When your correct weight has been entered, press the  key to accept the displayed value.
- You are prompted to enter a time goal. The treadmill displays a default time of 99 minutes. You may enter any time from 1 to 99 minutes.
 - Use the  keys to enter your desired time goal; or press the  or  key, as necessary, to increase or decrease the displayed value in 1 minute increments.
 - When your desired goal has been entered, press the  key to accept the displayed value.

To calculate your training zone, use the following formulas:
(theoretical max HR = 220 - Age)

















Heart Rate Training Range Upper Level

$$\frac{\text{Your Theoretical Max}}{\text{Training Range Upper Limit}} \times 0.75 = \frac{\text{Training Range Upper Limit}}{\text{Your Theoretical Max}}$$

Heart Rate Training Range Lower Level

$$\frac{\text{Your Theoretical Max}}{\text{Training Range Lower Limit}} \times 0.60 = \frac{\text{Training Range Lower Limit}}{\text{Your Theoretical Max}}$$

***NOTE:** Calculating your theoretical maximum heart rate using age is an approximation. For more information, please contact a fitness professional or doctor.*







5. You are prompted to enter your age.
 - Use the  keys to enter your age, or press the  or  key, as necessary, to increase or decrease the displayed value in 1 year increments.
 - When your correct age has been entered, press the  key to accept the displayed value.
6. You are prompted to enter an upper heart rate limit. The treadmill displays a default upper heart rate limit that is based on 80% of your theoretical maximum heart rate (220 BPM - age). You may enter any value from 90 to 200 BPM.
 - Use the  keys to enter an upper heart rate limit, or press the  or  key, as desired, to increase or decrease the heart rate limit in 1 BPM increments.
 - When the desired upper heart rate limit has been entered, press the  key to accept the displayed value.
7. You are prompted to enter a lower heart rate limit. The treadmill displays a default lower heart rate limit that is based on 60% of your theoretical maximum heart rate (220 BPM - age). You may enter any value from 70 BPM to 20 BPM less than the upper heart rate limit set in step 7.
 - Use the  keys to enter a lower heart rate limit, or press the  or  key, as desired, to increase or decrease the heart rate limit in 1 BPM increments.
 - When the desired lower heart rate limit has been entered, press the  key to accept the displayed value.
8. You are prompted to enter a maximum speed. You can specify a desired speed from 0.5 to 12.5 mph (0.8 to 20.0 kph).
 - Use the  keys to enter the desired maximum speed; or press the  or  key, as necessary, to increase or decrease the maximum speed in 0.1 unit increments.
 - When the desired maximum speed has been entered, press the  key to accept the displayed value.
9. You are prompted with a 3-second countdown, then the treadmill begins the program.
10. If desired, you can use the personal fan during your workout (see “Using the Personal Fan” for details).
11. You can pause the program during your workout by pressing the STOP key once. The program will pause for a preset period of time (30, 45, 60, 90 or 120 seconds, as set in Manager/Maintenance mode). Press the START key BEFORE the pause timer expires to resume your program. The treadmill returns to its minimum speed when you exit the pause mode.
12. When you have reached your workout goal, the treadmill enters the Cooldown cycle (see “Cooldown Cycle” for details). If you wish to exit the program before you have reached your workout goal, press the STOP key twice. The treadmill will slow to a stop. (Press the STOP key once during a Pause to exit the program.).













BURN FAT PROGRAM

NOTE: The BURN FAT program is available on the S-TRc and S-TRx treadmills only.

The BURN FAT program is similar to the CONSTANT HEART RATE program. It is designed to maintain your heart rate at a constant level equal to 62.55% of your theoretical maximum heart rate (220 BPM – age) by controlling treadmill speed and incline. Please note that your heart rate may vary above and below the target heart rate during this program.

To operate the BURN FAT Control program:

1. Stand on the running belt and press the  key.
 - If necessary, enter the Lockout ID to enable the bike for operation (see “Lockout ID Processing” for details).
2. You are prompted to select the desired ADVANCED WORKOUTS program. Press the  key to select the HEART RATE TRAINING programs, then press the  key when prompted to select the BURN FAT program.
3. You are prompted to enter your weight. The treadmill displays a default weight of 155 pounds (70 kg). You may enter any weight from 0 to 500 pounds (0 to 226 kg).
 - Use the  keys to enter your current weight; or press the  or  key, as necessary, to increase or decrease the displayed weight in 1 pound (or 1 kg) increments.
 - When your correct weight has been entered, press the  key to accept the displayed value.
4. You are prompted to enter a time goal. The treadmill displays a default time of 99 minutes. You may enter any time from 1 to 99 minutes.

- Use the  keys to enter your desired time goal; or press the  or  key, as necessary, to increase or decrease the displayed value in 1 minute increments.
 - When your desired goal has been entered, press the  key to accept the displayed value.
5. You are prompted to enter your age.
 - Use the  keys to enter your age, or press the  or  key, as necessary, to increase or decrease the displayed value in 1 year increments.
 - When your correct age has been entered, press the  key to accept the displayed value.
 6. You are prompted to enter a maximum speed. You can specify a desired speed from 0.5 to 12.5 mph (0.8 to 20.0 kph).
 - Use the  keys to enter the desired maximum speed; or press the  or  key, as necessary, to increase or decrease the maximum speed in 0.1 unit increments.
 - When the desired maximum speed has been entered, press the  key to accept the displayed value.
 7. You are prompted with a 3-second countdown, then the treadmill begins the program.
 8. If desired, you can use the personal fans during your workout (see “Using the Personal Fans” for details).
 9. You can pause the program during your workout by pressing the STOP key once. The program will pause for a preset period of time (30, 45, 60, 90 or 120 seconds, as set in Manager/Maintenance mode). Press the START key BEFORE the pause timer expires to resume your program. The treadmill returns to its minimum speed when you exit the pause mode.
 10. When you have reached your workout goal, the treadmill enters the Cooldown cycle (see “Cooldown Cycle” for details). If you wish to exit the program before you have reached your workout goal, press the STOP key twice. The treadmill will slow to a stop. (Press the STOP key once during a Pause to exit the program.).











FITNESS TESTS





NOTE: The *FITNESS TEST* and *FIREFIGHTER FITNESS TEST* programs are available on the *S-TRc* and *S-TRx* treadmills only.

To operate the Fitness Test program:

The *FITNESS TEST* is a modified version of the Balke and Ware protocol for maximal VO₂ treadmill testing. The original Balke-Ware protocol is a 20-minute test with a maximum elevation of 20%. Since most users prefer an 8-12 minute test and the **STAR TRAC S SERIES TREADMILLS** have a maximum elevation of 15%, the test has been modified to last 12 minutes with a maximum incline of 12%. This protocol is appropriate for all users, but is mostly used for older, deconditioned or patient groups. During the *FITNESS TEST*, treadmill speed remains at a constant 3.4 mph. Treadmill incline is set at 0% during the first minute, increases to 2% during the second minute, and increases by 1%-per-minute for the remainder of the test. Your heart rate results are compared with charted data for your corresponding age and gender. Test results include your calculated VO₂ max. VO₂ max is a physiological measurement of a body’s ability to absorb oxygen, and has specific correlation to your fitness level.

NOTE: You must wear the heart rate strap during the *FITNESS TEST* to monitor your heart rate.

1. Stand on the running belt and press the  key.
 - If necessary, enter the Lockout ID to enable the treadmill for operation (see “Lockout ID Processing” for details).
2. You are prompted to select the desired *ADVANCED WORKOUTS* program. Press the  key to select the *FITNESS TEST* programs, then press the  key to select the *FITNESS TEST*.
3. You are prompted to enter your weight. The treadmill displays a default weight of 155 pounds (70 kg). You may enter any weight from 0 to 500 pounds (0 to 226 kg).
 - Use the  keys to enter your current weight; or press the  or  key, as necessary, to increase or decrease the displayed weight in 1 pound (or 1 kg) increments.
 - When your correct weight has been entered, press the  key to accept the displayed value.
4. You are prompted to enter your gender.
 - Press the  key to set the gender to “male”, press the  key to set the gender to “female.”
 - When your correct gender has been entered, press the  key to accept the displayed value.
5. You are prompted to enter your age.

- Use the  keys to enter your age; or press the  or  key, as necessary, to increase or decrease the displayed value in 1 year increments.
 - When your correct age has been entered, press the  key to accept the displayed value.
6. You are prompted with a 3-second countdown, then the treadmill begins the program.
 7. The FITNESS TEST runs for 12 minutes. During the test, the treadmill speed is set at 3.4 mph. The treadmill incline begins at 0% for the first minute, increases to 2% for the second minute, and increases by 1% thereafter for each remaining minute to a maximum incline of 12% during the final minute of the test.









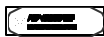

NOTE: During the test, you MAY NOT adjust treadmill speed or incline, and you MAY NOT pause the program. If your heart rate exceeds 150 BPM for more than one minute, the test will terminate automatically.
 8. If desired, you can use the personal fans during the FITNESS TEST (see “Using the Personal Fans” for details).
 9. When the test has concluded, the treadmill enters the Cooldown cycle (see “Cooldown Cycle” for details). If you wish to exit the program before you have reached your workout goal, press the STOP key twice. The treadmill will slow to a stop.





To operate the Firefighter Test program:

The FIREFIGHTER TEST is based on the Gerkin Protocol developed by Dr. Richard Gerkin of the Phoenix (Arizona) Fire Department. It is a sub-maximal graded treadmill evaluation used by many Fire Departments across the United States to assess the condition of the firefighters. The program operates as follows:

- **Warm-Up:** During warm-up, the treadmill runs at 3.0 mph (4.8 kph), 0% incline for 3 minutes.
- **Stage 1:** At 3 minutes, treadmill speed increases gradually to 4.5 mph (7.2 kph). The test begins at 4.5 mph (7.2 kph). During the test, heart rate is continuously monitored.
- **Stage 2:** After one minute, treadmill incline increases to 2%.
- **Stage 3:** After one minute, treadmill speed increases to 5.0 mph (8.0 kph).
- **Stages 4 through 11:** After every odd minute, treadmill incline increases an additional 2%. After every even minute, treadmill speed increases by 0.5 mph (0.8 kph). Once the user’s heart rate exceeds the target HR (85% of maximum), the individual continues the elevation for an additional 15 seconds. During this 15 second period, the evaluation remains at the stage where the target HR is exceeded, with speed or grade unchanged. If the HR does not return to or below the target HR, the evaluation ends and the final evaluation stage is recorded. If the HR returns to or below the target HR, the program continues at the point where it would have been had the program not stabilized for 15 seconds.
- **Test Completion:** The test is completed when user heart rate exceeds target for more than 15 seconds or the user completes all 11 stages, whichever occurs first. The treadmill will enter a Cooldown cycle for 3 minutes at 3.0 mph (4.8 kph), 0% incline.

NOTE: You must wear the heart rate strap during the FIREFIGHTER TEST to monitor your heart rate.

1. Stand on the running belt and press the  key.
 - If necessary, enter the Lockout ID to enable the treadmill for operation (see “Lockout ID Processing” for details).
2. You are prompted to select the desired ADVANCED WORKOUTS program. Press the  key to select the FITNESS TEST programs, then press the  key to select the FIREFIGHTER TEST.
3. You are prompted to enter your weight. The treadmill displays a default weight of 155 pounds (70 kg). You may enter any weight from 0 to 500 pounds (0 to 226 kg).
 - Use the  keys to enter your current weight; or press the  or  key, as necessary, to increase or decrease the displayed weight in 1 pound (or 1 kg) increments.
 - When your correct weight has been entered, press the  key to accept the displayed value.
4. You are prompted to enter your gender.
 - Press the  key to set the gender to “male”, press the  key to set the gender to “female.”
 - When your correct gender has been entered, press the  key to accept the displayed value.
5. You are prompted to enter your age.

- Use the  keys to enter your age; or press the  or  key, as necessary, to increase or decrease the displayed value in 1 year increments.
 - When your correct age has been entered, press the  key to accept the displayed value.
6. You are prompted with a 3-second countdown, then the treadmill begins the program.
 7. The FIREFIGHTER TEST runs for 12 minutes. The test begins with the treadmill speed set at 3.4 mph and the incline set at 0%. After one minute, treadmill incline increases to 2%. After one more minute, treadmill speed increases to 5.0 mph (8.0 kph). For the remainder of the program: After every odd minute, treadmill incline increases an additional 2%, and after every even minute, treadmill speed increases by 0.5 mph (0.8 kph).









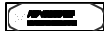

NOTE: During the test, you MAY NOT adjust treadmill speed or incline, and you MAY NOT pause the program. If your heart rate exceeds the target heart rate (85% of maximum), the treadmill remains at the current speed and elevation for 15 seconds. If your heart rate DOES NOT return to or below the target heart rate during this time, the test will terminate automatically. If your heart rate DOES return to or below the target heart rate, the test continues.
 8. If desired, you can use the personal fans during the FIREFIGHTER TEST (see “Using the Personal Fans” for details).
 9. When the test has concluded, the treadmill enters the Cooldown cycle (see “Cooldown Cycle” for details). If you wish to exit the program before you have reached your workout goal, press the STOP key twice. The treadmill will slow to a stop.

GOAL WORKOUTS

NOTE: The GOAL WORKOUTS programs are available on the S-TRc and S-TRx treadmills only.









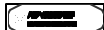

The GOAL WORKOUTS programs allow the user to set a personal program goal based either on calories expended or distance traveled.

To operate the CALORIE GOAL program:



















1. Stand on the running belt and press the  key.
 - If necessary, enter the Lockout ID to enable the treadmill for operation (see “Lockout ID Processing” for details).
2. You are prompted to select the desired ADVANCED WORKOUTS program. Press the  key to select the GOAL WORKOUTS programs, then press the  key to select the CALORIES program.
3. You are prompted to enter your weight. The treadmill displays a default weight of 155 pounds (70 kg). You may enter any weight from 0 to 500 pounds (0 to 226 kg).
 - Use the  keys to enter your current weight; or press the  or  key, as necessary, to increase or decrease the displayed weight in 1 pound (or 1 kg) increments.
 - When your correct weight has been entered, press the  key to accept the displayed value.
4. You are prompted to enter your goal for calories expended. You may enter any calorie goal from 1 to 999 calories.
 - Use the  keys to enter your calorie goal; or press the  or  key, as necessary, to increase or decrease the displayed calorie goal in 1 calorie increments.
 - When your desired calorie goal has been entered, press the  key to accept the displayed value.
5. You are prompted with a 3-second countdown, then the treadmill begins the program.
6. If desired, you can use the personal fans during your workout (see “Using the Personal Fans” for details).
7. You can pause the program during your workout by pressing the STOP key once. The program will pause for a preset period of time (30, 45, 60, 90 or 120 seconds, as set in Manager/Maintenance mode). Press the START key BEFORE the pause timer expires to resume your program. The treadmill returns to its minimum speed when you exit the pause mode.
8. When you have reached your workout goal, the treadmill enters the Cooldown cycle (see “Cooldown Cycle” for details). If you wish to exit the program before you have reached your workout goal, press the STOP key twice. The treadmill will slow to a stop. (Press the STOP key once during a Pause to exit the program.)

To operate the 5K LOOP or 10K LOOP DISTANCE GOAL program:

1. Stand on the running belt and press the  key.
 - If necessary, enter the Lockout ID to enable the treadmill for operation (see “Lockout ID Processing” for details).

2. You are prompted to select the desired **ADVANCED WORKOUTS** program. Press the  key to select the **GOAL WORKOUTS** programs, then press the  key to select the **DISTANCE GOAL** programs. Press the  key to select the **5K LOOP** program; press the  key to select the **10K LOOP** program.
3. You are prompted to enter your weight. The treadmill displays a default weight of 155 pounds (70 kg). You may enter any weight from 0 to 500 pounds (0 to 226 kg).
 - Use the     keys to enter your current weight; or press the  or  key, as necessary, to increase or decrease the displayed weight in 1 pound (or 1 kg) increments.
 - When your correct weight has been entered, press the  key to accept the displayed value.
4. You are prompted with a 3-second countdown, then the treadmill begins the program.
5. If desired, you can use the personal fan during your workout (see “Using the Personal Fan” for details).
6. You can pause the program during your workout by pressing the **STOP** key once. The program will pause for a preset period of time (30, 45, 60, 90 or 120 seconds, as set in Manager/Maintenance mode). Press the **START** key **BEFORE** the pause timer expires to resume your program. The treadmill returns to its minimum speed when you exit the pause mode.
7. When you have reached your workout goal, the treadmill enters the **Cooldown** cycle (see “Cooldown Cycle” for details). If you wish to exit the program before you have reached your workout goal, press the **STOP** key twice. The treadmill will slow to a stop. (Press the **STOP** key once during a **Pause** to exit the program).

To operate the CUSTOM DISTANCE GOAL program:

1. Stand on the running belt and press the  key.
 - If necessary, enter the Lockout ID to enable the treadmill for operation (see “Lockout ID Processing” for details).
2. You are prompted to select the desired **ADVANCED WORKOUTS** program. Press the  key to select the **GOAL WORKOUTS** programs, then press the  key to select the **DISTANCE GOAL** programs. Press the  key to select the **CUSTOM DISTANCE** program.
3. You are prompted to enter your weight. The treadmill displays a default weight of 155 pounds (70 kg). You may enter any weight from 0 to 500 pounds (0 to 226 kg).
 - Use the     keys to enter your current weight; or press the  or  key, as necessary, to increase or decrease the displayed weight in 1 pound (or 1 kg) increments.
 - When your correct weight has been entered, press the  key to accept the displayed value.
4. You are prompted to enter your goal for distance traveled. You may enter any distance goal from 1 to 999 miles (or kilometers).
 - Use the     keys to enter your your distance goal; or press the  or  key, as necessary, to increase or decrease the displayed distance in 1 mile (or kilometer) increments.
 - When your desired distance goal has been entered, press the  key to accept the displayed value.
5. You are prompted with a 3-second countdown, then the treadmill begins the program.
6. If desired, you can use the personal fans during your workout (see “Using the Personal Fans” for details).
7. You can pause the program during your workout by pressing the **STOP** key once. The program will pause for a preset period of time (30, 45, 60, 90 or 120 seconds, as set in Manager/Maintenance mode). Press the **START** key **BEFORE** the pause timer expires to resume your program. The treadmill returns to its minimum speed when you exit the pause mode.
8. When you have reached your workout goal, the treadmill enters the **Cooldown** cycle (see “Cooldown Cycle” for details). If you wish to exit the program before you have reached your workout goal, press the **STOP** key twice. The treadmill will slow to a stop. (Press the **STOP** key once during a **Pause** to exit the program).

TRAINING INFORMATION

To assist you in your training program, this chapter provides you with exercise principles, tips for training and hints to stay motivated climbing up the conditioning ladder.

THE FIRST STEP TO A BETTER LIFESTYLE

With the **STAR TRAC S SERIES TREADMILL**, you've taken an important first step to achieving your fitness goal. But, it's important to have the right fitness tools to stay motivated and achieve results. About half of all people who start an exercise program quit within 6-12 months. What is the key to success for the other half? Motivation!

As you may know, exercise reduces the factors associated with the development of heart disease, hypertension, diabetes, obesity and back disorders. Researchers have concluded that a healthful life-style including regular exercise can extend your life expectancy by as much as fifteen years! More importantly, exercise will help make all your years - no matter how many there are - productive and enjoyable.

What constitutes a regular exercise regimen? If you stick with a consistent workout program for 30 minutes, three times a week, for 3 months, you will be on your way to a long-term fitness program. Part of the motivation for a regular exercise regimen will stem from the results you will both see and feel after three months. In fact, many exercisers start to experience results in as early as one week!

GETTING STARTED - WALKERS AND RUNNERS

For fitness newcomers or veterans, the **STAR TRAC S SERIES TREADMILL** offers tailor-made walking and running programs. The following information will be useful when developing your own exercise program.

Assessing Fitness Level

Conducting a cardiovascular endurance assessment is a great way to start an exercise regimen. The results obtained from the FITNESS TEST on your **STAR TRAC S SERIES TREADMILL** provide great baseline information to help determine your proper workout intensity levels, and it serves as a great motivational tool for showing improvements over time. Below is a simple test to follow. This assessment should only be used with apparently healthy adults.

The FITNESS TEST is a modified version of the Balke and Ware protocol for maximal VO₂ treadmill testing. The FITNESS TEST requires 12 minutes to complete. During the FITNESS TEST, treadmill speed remains at a constant 3.4 mph. Treadmill incline is set at 0% during the first minute, increases to 2% during the second minute, and increases by 1%-per-minute for the remainder of the test. Your heart rate results are compared with charted data for your corresponding age and gender. Test results include your calculated VO₂ max. VO₂ max is a physiological measurement of a body's ability to absorb oxygen, and has specific correlation to your fitness level.

The Warm Up

Warming-up prepares you for physical activity by increasing body temperature, allowing the muscles to relax and contract more smoothly and efficiently, and lubricating the joints. Good warm-up exercises include walking, bicycling, jogging and light calisthenics. Proper warm-up may also help prevent injuries and reduce the likelihood of cardiac abnormalities. A mild sweat is a good indication that the body is sufficiently warmed-up.

Pre-Exercise Stretching

A flexibility program prior to walking or running is designed to help improve performance and reduce the risk of injury during the activity. When you are stretching, remember these simple rules:

- An active warm-up is recommended prior to vigorous stretching exercises. If stretches are performed, they should be done with caution, so as to not over stretch muscles.
- Do not force a stretch. The degree of stretching should not cause significant pain.
- Hold the stretch for 10 to 15 seconds without bouncing.
- Repeat each stretch two or three times for increased flexibility.
- Try to maintain good posture and remember to breathe during the stretch.

The following muscle groups should be stretched/warmed up for any walking or running program.

- Quadriceps
- Hamstrings
- Calves
- Glutes
- Inner thighs
- Back Muscles

- Chest
- Shoulder muscles
- Hip flexors

F.I.T. Principle

Every cardiovascular program should be developed based on frequency, intensity and duration.

1. **Frequency** - the number of exercise sessions per week.

Regular exercise should be performed at least three or four days a week to be beneficial, although fewer sessions may be sufficient for some. Those in superior physical condition typically train five to seven days per week.

2. **Intensity** - how hard each exercise is.

Intensity is dependent upon one's fitness level. The range established by American College of Sports Medicine is 60% to 90% of maximal heart rate. If you are a beginning exerciser, maintaining an intensity level around 60% is beneficial. Typically, an estimated heart rate range is determined using a formula of 220-Age, factoring in resting heart rate, then multiplying by the desired percentage. See the accompanying chart on this page.

The **STAR TRAC S SERIES TREADMILL** offers both contact heart rate grips and heart rate strap compatibility, providing for easy monitoring of your heart rate during your workout. However, if you need to monitor your pulse manually, find the carotid or radial artery with your index finger, take a ten second count and multiply by six to determine your heart rate.

RPE SCALE	
0	Nothing at all
1	Very, Very Easy
2	Very Easy
3	Easy
4	Moderate
5	Moderate/Strong
6	Strong
7	Very Strong
8	Very, Very Strong
9	Extremely Strong
10	Strongest

Another common method for measuring workout intensity is Rate of Perceived Exertion (RPE). This method provides a scale in which an exerciser can subjectively determine how hard the exercise feels while working in a target training range. Descriptive words correspond with a 0 through 10 rating scale. The target range to exercise is between 4 and 6 on the rating scale. (This is a great method to use for those taking medications that effect one's heart rate and for those who want to fine tune how to be in touch with how their bodies respond to exercise). See the accompanying chart on this page.

3. **Time** - the duration of each exercise session.

The optimum duration of an exercise session depends on the intensity. Typically, an exercise session lasts for at least 20 to 30 minutes, although highly conditioned individuals often train continuously for an hour or longer. The duration of training is sometimes increased while intensity is decreased. This happens early in the training program to prepare the musculoskeletal system for vigorous exercise and to reduce the chance of injury.

REMEMBER: Use the F.I.T. principle as a guide to establish your program, however, make sure that you pay attention to how your body feels. Under-exercising may not be adequate for desired results. However, over-exercising can lead to injuries. Be sure to start slowly, and pace yourself.

The Cool Down

A gradual cool down helps prevent blood from pooling in your legs which may result in feeling light headed and dizzy. Active contraction by continuous movement of your legs and arms during the cool down helps pump blood back to your heart and brain. It is also important to stretch your muscles during the cool down. Use stretching exercises similar to those done during the warm up (see muscles listed in the warm up section). Stretching in this phase can be held for a longer period to help avoid muscle stiffness.

CLIMBING THE CONDITIONING LADDER - SUGGESTED PROGRAMS

The programs outlined below were developed by the director of services at the Lutheran General Hospital in Illinois. They were developed to help maintain or improve one's level of fitness, depending on the current fitness level. Follow each of the 6 week programs as they move in progression. Once Program V is achieved, continue at this same level of intensity for continued programs, however, add variety by changing around workouts per week, duration or add interval training (high intensity mixed with low intensity 70% - 90%). To add variety to intensity make, use of the incline feature on the **STAR TRAC S SERIES TREADMILL**. This feature gives you an incline range from 0% to 15%.

Determining your Target Heart Rate Range

LOWER TARGET HEART RATE

220

- _____ Your Age

= _____ Estimated Max. Heart Rate

- _____ Your Resting Heart Rate

= _____ Value

X _____ 60%

= _____ Estimated Target

+ _____ Your Resting Heart Rate

= _____ Target Heart Rate @ 60%

UPPER TARGET HEART RATE

220

- _____ Your Age

= _____ Estimated Max. Heart Rate

- _____ Your Resting Heart Rate

= _____ Value

X _____ 80%

= _____ Estimated Target

+ _____ Your Resting Heart Rate

= _____ Target Heart Rate @ 80%

Lower Target Heart Rate

Upper Target Heart Rate

Program I:				
	Week	Heart Rate (%)	Duration (minutes)	Workouts per Week
	1,2	60 to 65	15	3
	3,4	60 to 65	15	3
	5,6	60 to 65	15	3
Program II:				
	Week	Heart Rate (%)	Duration (minutes)	Workouts per Week
	1,2	65 to 70	20	3
	3,4	65 to 70	20	3
	5,6	65 to 70	20	3
Program III:				
	Week	Heart Rate (%)	Duration (minutes)	Workouts per Week
	1,2	70 to 75	20	4
	3,4	70 to 75	25	4
	5,6	70 to 75	25	4
Program IV:				
	Week	Heart Rate (%)	Duration (minutes)	Workouts per Week
	1,2	75 to 80	25	4
	3,4	75 to 80	25	4
	5,6	75 to 80	30	4
Program V:				
	Week	Heart Rate (%)	Duration (minutes)	Workouts per Week
	1,2	80 to 85	30	4
	3,4	80 to 85	35	4
	5,6	80 to 85	35	4

PROGRAM VARIATION ON THE S SERIES TREADMILL

Everyone can benefit from using treadmills because walking, jogging, and running provide results. The **STAR TRAC S SERIES TREADMILL** gives you infinite workout possibilities. Here are some suggested programs for the deconditioned, average and athletic users.

Deconditioned (beginning) Exercisers

This group, which includes the overweight, cardiac rehabilitated and the senior population, requires more personal attention and one-on-one feedback for motivation rather than fancy programs built into the treadmill. Keeping everything simple is key. Before starting to exercise, becoming acquainted with basic treadmill features, including emergency stop button helps to make the exercise experience more fulfilling. The QUICK START program is a great place to start. The user, at all times has control of his/her workout, and all basic information feedback is provided. Other programs recommended for this group are the HEART RATE CONTROL programs. These programs are great for learning how the heart rate responds to various levels of intensity. However, knowing one's target training range is necessary to operate these programs. Starting speed for this group ranges from 2.0 to 3.0 mph. The incline shouldn't exceed 5% elevation unless instructed differently by a fitness professional. Progression of intensity and time is gradual (weekly) and frequency progress may not occur until after 4 weeks.

Average Exercisers

This group is classified by those who live somewhat active lifestyles (exercising about twice a week) or fit into the age category of 18-35. Confidence levels from this group are higher than the deconditioned group, therefore the willingness to try new or more advanced programs is greater. While most tend to enter immediately into a quick start, encouraging use of other programs may keep participation consistent and workouts more alive. The BURN CALORIES and INCREASE ENDURANCE programs offer great variations that make good use of incline, making a running or walking workout more interesting and challenging.

Starting speed for this group ranges from about 3.0 to 3.5 mph. Typically, exercisers in this category will not use elevation, however, it is strongly encouraged for varied intensity and variability. Exercisers in this category may not be comfortable exceeding 10% incline. Progression of intensity and time is gradual (weekly) and frequency progress may not occur until after 4 weeks.

Athletic Exercisers

Competitive and advance exercisers often look for varied programs for sports enhancement or maintenance. If competition is an interest, the 5K LOOP and 10K LOOP programs offer the user a route to follow and a means to monitor progress. While

many of the programs include a warm-up phase, in the MANUAL make sure a warm-up and cool-down period is factored in. If you are doing a running workout, a good starting speed is 5.0 mph. If you are doing a walking or jogging workout, a good starting speed is 3.8 mph.

Target Training Chart

Use the following table for a quick glance at your target training zone for both heart rate and rate of perceived exertion.

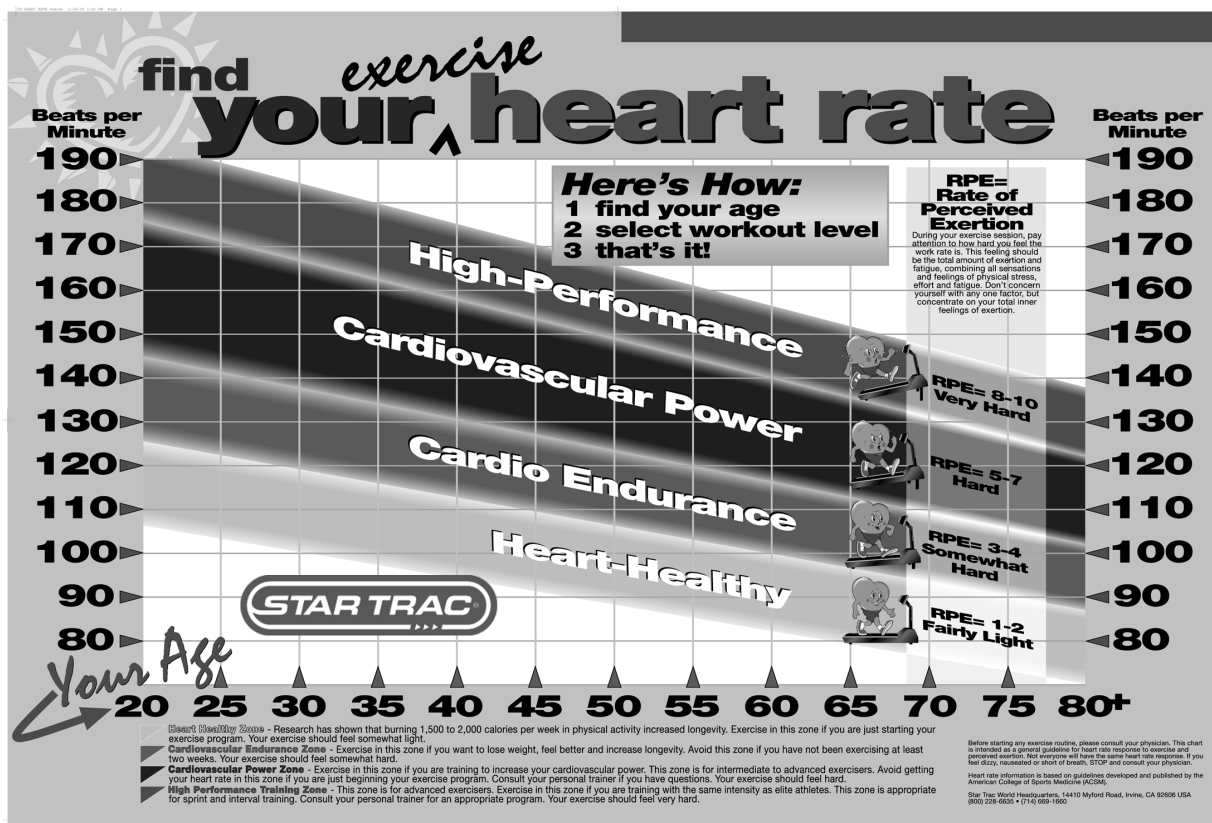

TIPS TO STAY MOTIVATED

Set Goals and Reward yourself: Determine precisely what you want to achieve. By setting challenging, specific goals, you are setting yourself up to achieve them. When you achieve those goals, reward yourself. "It's crucial (to reward yourself)," according to Lauve Metcalfe, Director of Program Development at the Campbell Institute for Health and Fitness in Camden, New Jersey. "Who quits a program because he's having too much fun?" Example of tangible rewards: A new pair of running shoes if you knock a minute off your time in the mile.

Schedule your workout: Get into the habit of working out at the same time each day. And, write that time on your calendar. Make keeping your workout schedule as important as eating or sleeping.

Watch your progress: Follow your movement on the Graphic Display to help pass time and cut down on boredom.

Plan an active vacation: If you know you're going on a walking tour of Paris or on a mountain hiking trip next summer, you'll look forward to getting into shape for it.

Exercise in numbers: Get a workout partner or exercise in a group. This will offer you support and a level of accountability, (not to let your partner or group down for not showing up).

Train for a race or enter an event: A race is a great goal toward which to work, and the excitement of competition is sure to keep you going. Try a 5K or a 10K run.

Avoid too much too soon: Stress and discomfort of an over-aggressive program can be overwhelming and lead to injuries.

Vary your workouts: Once accustomed to a program, vary the workout so that your routine doesn't become mundane. It's also important to recruit new muscle fibers to a new exercise to keep the body stimulated to make improvements.

PREVENTATIVE MAINTENANCE

Star Trac strongly recommends performing regular preventive maintenance on your **STAR TRAC S SERIES TREADMILL**. Without regularly scheduled maintenance, normal wear and tear may cause cumulative effects, such as misalignment or premature wear. This may result in downtime. For this reason, we highly recommend following the maintenance schedules. Additionally, unusual symptoms, such as display codes and blown circuit breakers, should be reported to **STAR TRAC PRODUCT SUPPORT DEPARTMENT** at (800) 503-1221, or USA 1-714-669-1660.

DAILY MAINTENANCE

- Remove excessive accumulations of dust, dirt, and other substances by using a clean soft cloth and a non-abrasive liquid cleaner, such as Formula 409 or FANTASTIK. Wipe down the display board, handrails, shroud and heart rate grips.
- **NOTE:** *DO NOT spray the cleaner directly onto the display board or heart rate grips. Do not use liquid cleaner under the running belt.*
- To ensure the longevity of the running belt, clean under the running belt with a soft, dry cloth. To clean, slide the cloth between the running belt and deck from one side of the frame to the other (you may need a ruler or similar tool to slide the towel under the belt), then, holding the edges of the cloth, pull the cloth from the headroller down to the tailroller.
- **NOTE:** *DO NOT clean the running belt by activating the treadmill.*
- Inspect the running belt for alignment and tension. Do not tighten the running belt every day. If you notice slipping, adjust the running belt tension using the instructions provided in “Adjustments-Slipping-Running Belt” (later in this chapter), or contact Product Support as described at the beginning of this chapter.
- Ensure the power cord is not under the treadmill and is positioned away from the elevation screws. This will prevent the power cord from being pinched or from binding up the elevation screws.

WEEKLY MAINTENANCE

- Vacuum the floor under and around the treadmill. Do so with the treadmill at its maximum elevation or moved to another spot.
- **NOTE:** *Take care not to damage the power cord while vacuuming.*
- Inspect the inside surface of the running belt and the top surface of the running deck for unusual wear. Check the belt for a “glazed” condition (a smooth almost melted appearance). If the running belt appears glazed, replace the running belt and flip or replace the running deck.
- **NOTE:** *Never install a new running belt on a used deck.*
- Inspect the display and handrail screws for security, and retighten if necessary.
- Inspect the display panel/keypad for wear.

BI-WEEKLY MAINTENANCE

WARNING: *To prevent personal injury, always turn the treadmill off and unplug the power cord before performing maintenance inside the motor compartment.*

- Remove the motor shroud and vacuum around the motor and its ventilation holes. Avoid bumping or damaging parts normally protected by the shroud.

MONTHLY MAINTENANCE

- Wipe the elevation screws down with a clean dry cloth and coat them with silicon lubricant spray to prevent rust accumulation.

ADJUSTMENTS

The running belt and its headroller, drive belt, tailroller, and running deck are designed to be self-centering, slip-free, and smooth-operating without the need for frequent adjustments. Running belt sideward movement, slipping, or grinding after extended use, or thumping during initial use, may be corrected by the following procedures:

Change Sideward Movement to TRACKING: If the running belt is not centered on the tailroller and is either too far left or right, adjust tracking using the following steps:

1. Turn the treadmill on. Increase treadmill speed to 3.0 mph (5.0 kph).
2. Adjust tracking by adjusting the tailroller Allen screws (located at the back sides of the tailroller) with a 1/4" Allen wrench in 1/4-turn increments.

If the running belt is tracking to the left, adjust the running belt to track to the right. Tighten the left tailroller Allen screw by turning clockwise, or loosen the right tailroller bolt by turning counter-clockwise.

If the running belt is tracking to the right, adjust the running belt to track to the left. Tighten the right tailroller Allen screw by turning clockwise or loosen the left tailroller bolt by turning counter-clockwise.

3. After the running belt appears to be tracking properly, increase the treadmill speed to 10.0 mph (16.0 kph) and verify that the belt stays centered.

Slipping-Running Belt: Remove the motor shroud and operate the treadmill slowly at 1 to 2 mph (2 to 3 kph). While observing the headroller, walk on the belt and try to slow it down by gently applying pressure with your feet while holding the handrails. If only the running belt, and not the headroller, slows down, tighten the running belt by turning both the right and left tailroller adjustment bolts clockwise 1/4-turn. Repeat this adjustment until the running belt no longer slips, ensuring that you turn both tailroller bolts an equal number of turns. Re-install the motor shroud. If the headroller and the running belt both slow down, tighten the drive belt as described under "Slipping-Drive Belt", below.

Thumping: Turn the treadmill off. Turn the right and left tailroller adjustment bolts counter-clockwise with the M6 Allen wrench until the running belt is loose. Note the number of times each bolt is turned. Remove excess accumulated running deck wax from the tailroller with a credit card, a putty knife, or other flexible plastic implement. Tighten the running belt by turning the adjustment bolts clockwise the same number of turns as they were loosened. Turn the treadmill on and check for sideward movement and/or slipping of the running belt. Tighten the tailroller adjustment bolts further, if necessary, in 1/4-turn increments.

REWAX BELT

Periodic running belt rewaxing virtually eliminates belt down time, and maximizes the life of the belt. Whenever the present distance is 2000 miles (or 3000 km) more than the LAST DECK (last deck service), the start-up display will scroll REWAX BELT. This is a reminder to have your maintenance or service provider perform the 5-minute belt rewaxing procedure at your convenience. (Immediate service is not required). Wax is included in the treadmill.

TOOLS & MATERIALS

Bottle of Wax Powder (1)

Clean Towel (1)

Paint Stick or Ruler (1)

Diluted All-purpose Cleaner (409), or Bristle Brush

PROCEDURE

Apply wax powder while belt & deck are still warm (5 minutes minimum use) for optimum benefit.

1. **CAUTION:** turn treadmill power off and unplug the power cord before rewaxing the belt.
2. **CLEAN DECK & BELT:**
 - A. Using the paint stick or ruler, slide a towel under the middle of the belt from one side of the frame to the other.
 - B. Hold the edges of the towel; pull to the tailroller; pull to the headroller; then pull the belt down to wipe the remaining belt. TIP: Fold the dirty towel and shake into trash.
3. **LIFT BELT:** Lift the left side (facing display) of the belt, about 12 inches down from the motor shroud (see figure). Hold the belt up to elevate the belt from the deck.
4. **SPREAD WAX:** Flip the nozzle on the cap of the wax bottle. Point the nozzle at the deck. Be sure that the bottle is tilted at a downward angle. Squeeze the wax bottle twice between the running belt and the deck. TIP: Gently shake the bottle between each squeeze.
5. Repeat steps 3 and 4, about 18 inches from the end of the deck.
6. Repeat steps 3 through 5, on the right side of the belt/deck.
7. **WALK:** Plug in the treadmill. Turn the treadmill ON/OFF switch to the ON position. Start the treadmill at 1 mph and walk on all sections of the belt and deck for 1 minute to ensure the wax has been evenly distributed and worked-in properly.



8. **CLEANUP:** Turn the treadmill power OFF . Remove any excess wax with diluted cleaner (409) and towel. TIP: Blow away extra wax first (like dust), then wipe.
9. **DISPLAY UPDATE:** Update the LAST DECK service mileage to remove the REWAX BELT message.

MANAGER / MAINTENANCE MODE

After using your **STAR TRAC S SERIES TREADMILL** for a period of time, you may wish to change some of its settings.

MANAGER MODE

The Manager Settings allow you to query and modify the basic settings of your treadmill. To enter Manager Settings:

1. Press and hold the ,  and  keys together.
2. A beep will sound and “MANAGER SETTINGS” will scroll once across the PROFILE Window.
3. Release all keys. “SN” will display in the PROFILE Window; the associated numeric value for the parameter will display in the DISTANCE Window.

NOTE: The system will automatically exit Manager Settings if no key is pressed for 30 seconds.

The following keys are used to modify MANAGER SETTINGS:



Increase and Decrease Incline Keys: Display the next (Increase) and previous (Decrease) parameters. Keys may also be used to enter the desired value for the currently displayed parameter. Keys will repeat if held.



Numeric Keypad: Facilitates entry of the desired value for the displayed parameter. These keys *do not* save the new value – see **OK Key** below.



OK Key: Updates (saves) the value of the displayed parameter in Flash memory. “UPDATING” will scroll once across the PROFILE Window while the update is in process. When the update is complete, the PROFILE Window will show the new value for the parameter.

NOTE: To exit Manager Mode without saving any values or settings, press the STOP key.

NOTE: Unless otherwise specified, the **Item** (parameter) name is shown in the PROFILE Window, and the value of the parameter is shown in the DISTANCE Window.



The items that you may display and change with the previous keys are:

Item	Lowest Value	Highest Value	Default Value	Meaning
SN	0	9999	N/A	Serial Number. S Series Treadmill serial number (set by factory).
DSW	1.0	99.99	N/A	Display Software. Display panel software version number (set by factory). NOTE: Software checksum value is displayed in CALORIES Window; software Build value is displayed in TIME Window
OHR	0	9999	0	Operating Hours. Total operating hours.
DST	0	9999	0	Distance. Total distance traveled in miles or kilometers, based on current UNx setting.
UNx	UNE	UNM	UNE	Units. UNE (English) = units of pounds, miles, feet, inches UNM (Metric) = units of kilograms, kilometers, centimeters NOTE: Current value is shown in PROFILE Window.
TIM	5	99	99	Time. Maximum time in minutes allowed for a program, excluding cooldown.
WGT	1 (lb) 1 (kg)	500 (lb) 226 (kg)	155 (lb) 70 (kg)	Default Weight (to user). Typical weight in lb (UNx = UNE) or kg (UNx = UNM).
Lxx	N/A	N/A	LEN	Language. Display language; either LEN (English), LGE (German), LSP (Spanish), LDU (Dutch), LPO (Portuguese), LFR (French), LIT (Italian), LSW (Swedish) or LKA (Katakana). NOTE: Current value is shown in PROFILE Window.
LOE	OFF	ON	OFF	Lockout Enable. Enables/disables lockout function.
LOI	001	999	001	Lockout ID. Lockout override identification number.

Item	Lowest Value	Highest Value	Default Value	Meaning
MNS	0.3 (mi) 0.8 (k)	2.0 (mi) 3.2 (k)	0.5 (mi) 0.8 (k)	Minimum Speed. Treadmill minimum operating speed in miles or kilometers, based on current UNx setting.
MXS	5.0 (mi) 5.0 (k)	12.5 (mi) 20.0 (k)	5.0 (mi) 5.0 (k)	Maximum Speed. Treadmill maximum operating speed in miles or kilometers, based on current UNx setting.
ACC	25	60	25	Acceleration Time. Time in seconds to accelerate from current speed to a specified higher speed.
DEC	20	60	20	Deceleration Time. Time in seconds to decelerate from current speed to a specified lower speed.
AST	OFF	ON	OFF	Auto Stop Enable. Enables/disables Auto Stop function.
AFE	OFF	ON	ON	Auto Fan Enable. Enables/disables Auto Fan function.
PAU	30	120	60	Pause duration during a program, in seconds, either 30, 45, 60, 90 or 120.

MAINTENANCE MODE

Your Service Representative may need to check accumulated data about the past usage of your treadmill, test its display controls, or investigate error messages. For these reasons, your treadmill is equipped with a Maintenance Mode. The Maintenance Mode includes all of the items available through Manager Mode, plus additional items for Service and Diagnostic use. To enter Maintenance Mode:

1. Press and hold the ,  and  keys together.
2. A beep will sound and “MAINTENANCE SETTINGS” will scroll once across the PROFILE Window.
3. Release all keys. “SN” will display in the PROFILE Window; the associated numeric value for the parameter will display in the DISTANCE Window.

NOTE: The system will automatically exit MAINTENANCE SETTINGS if no key is pressed for 30 seconds.

The following keys are used to modify MANAGER SETTINGS:



Increase and Decrease Incline Keys: Display the next (Increase) and previous (Decrease) parameters. Keys will repeat if held.



Numeric Keypad: Facilitates entry of the desired value for the displayed parameter. These keys *do not* save the new value – see **OK Key** below.



OK Key: Updates (saves) the value of the displayed parameter in Flash memory. “UPDATING” will scroll once across the PROFILE Window while the update is in process. When the update is complete, the PROFILE Window will show the new value for the parameter.

NOTE: To exit Maintenance Mode without saving any values or settings, press the STOP key.

NOTE: Unless otherwise specified, the **Item** (parameter) name is shown in the PROFILE Window, and the value of the parameter is shown in the DISTANCE Window.

The items that you may display and change with the previous keys are:

Item	Lowest Value	Highest Value	Default Value	Meaning
SN	0	9999	N/A	Serial Number. S Series Treadmill serial number (set by factory).
DSW	1.0	99.99	N/A	Display Software. Display panel software version number (set by factory). NOTE: Software checksum value is displayed in CALORIES Window; software Build value is displayed in TIME Window
OHR	0	9999	0	Operating Hours. Total operating hours.
DST	0	9999	0	Distance. Total distance traveled in miles or kilometers, based on current UNx setting.

Item	Lowest Value	Highest Value	Default Value	Meaning
UNx	UNE	UNM	UNE	Units. UNE (English) = units of pounds, miles, feet, inches UNM (Metric) = units of kilograms, kilometers, centimeters NOTE: Current value is shown in PROFILE Window.
TIM	5	99	99	Time. Maximum time in minutes allowed for a program, excluding cooldown.
WGT	1 (lb) 1 (kg)	500 (lb) 226 (kg)	155 (lb) 70 (kg)	Default Weight (to user). Typical weight in lb (UNx = UNE) or kg (UNx = UNM).
Lxx	N/A	N/A	LEN	Language. Display language; either LEN (English), LGE (German), LSP (Spanish), LDU (Dutch), LPO (Portuguese), LFR (French), LIT (Italian), LSW (Swedish) or LKA (Katakana). NOTE: Current value is shown in PROFILE Window.
LOE	OFF	ON	OFF	Lockout Enable. Enables/disables lockout function.
LOI	001	999	001	Lockout ID. Lockout override identification number.
MNS	0.3 (mi) 0.8 (k)	2.0 (mi) 3.2 (k)	0.5 (mi) 0.8 (k)	Minimum Speed. Treadmill minimum operating speed in miles or kilometers, based on current UNx setting.
MXS	5.0 (mi) 5.0 (k)	12.5 (mi) 20.0 (k)	5.0 (mi) 5.0 (k)	Maximum Speed. Treadmill maximum operating speed in miles or kilometers, based on current UNx setting.
ACC	25	60	25	Acceleration Time. Time in seconds to accelerate from current speed to a specified higher speed.
DEC	20	60	20	Deceleration Time. Time in seconds to decelerate from current speed to a specified lower speed.
AST	OFF	ON	OFF	Auto Stop Enable. Enables/disables Auto Stop function.
AFE	OFF	ON	OFF	Auto Fan Enable. Enables/disables Auto Fan function.
PAU	30	120	60	Pause duration during a program, in seconds, either 30, 45, 60, 90 or 120.
MNP	4	110	25	Minimum PWM. Pulse duty cycle to obtain the selected MN SPD. Divide MN PWM by 512 to get % duty cycle.
HFP	50	340	197	½ Maximum PWM. Pulse duty cycle to obtain ½ maximum speed. Divide ½ MX SPD by 512 to get % duty cycle.
MXP	172	511	400	Maximum PWM. Pulse duty cycle to obtain the selected MX SPD. Divide MX PWM by 512 to get % duty cycle.
CRV	31	125	31	Counts/Revs. Number of counts for each motor shaft revolution.
10R	220	740	356	10 Rev distance in tenths of inches. Inches of running belt travel for 10 flywheel revolutions, always measured in inches.
PD1	1	150	1	Person Detect 1. Threshold used for Auto Stop.
PD2	1	150	1	Person Detect 2. Threshold used for Auto Stop.
PD3	1	150	1	Person Detect 3. Threshold used for Auto Stop.
NST	0	255	0	No Stop Counter. Number of times No Stop Counter switch was down or disconnected on power-up since last reset.
KYD	0	255	0	Key Down Counter. Number of times key other than 5 or 8 was down on power-up since last reset.
SPC	0	255	0	Speed Change Counter. Number of times speed changed suddenly more than 2 mph (UNITS=English) or 2 km/hr (UNITS=Metric) since last reset.
ELS	0	255	0	Elevation Stall Counter. Number of times elevation failed to change (stalled)

Item	Lowest Value	Highest Value	Default Value	Meaning
ELR	0	255	0	since last reset. Elevation Range Counter. Number of times elevation was out of range (not between 0% and 15%) at power-up since last reset.
ELL	0	255	0	Elevation Lost Counter. After pressing START and reaching 0% reset, the number of times elevation went beyond 0% to 15%, since last reset.
CMS	0	255	0	Check Motor System Counter. Number of times motor current measured 0 when commanded to move.
CSS	0	255	0	Check Speed System Counter. Number of times speed sensor feedback went to 0 while motor was commanded to move.
ELZ	172	242	172	Elevation Zero. Representation of voltage to elevation motor to obtain 0% elevation. Multiply ELEV ZERO by 0.019608 to get actual voltage.
ELM	25	170	25	Elevation Max. Representation of voltage to elevation motor to obtain 15% (maximum) elevation (incline). Multiply ELEV MAX by 0.019608 to get actual voltage.
DCK	0	65,535	0	Last Deck. Number of miles (UNITS=English), or km (UNITS=Metric) since the running deck was last serviced or replaced.
BLT	0	65,535	0	Last Belt. Number of miles (UNITS=English), or km (UNITS=Metric) since the running belt was last replaced.
MTR	0	65,535	0	Last Motor. Number of miles (UNITS=English), or km (UNITS=Metric) since the motor brushes were last serviced or replaced.
MDL	1	3	N/A	Model Number. 1 – S-TRc 2 – S-TRx 3 – S-TR
QKS	0	9999	0	Quick Start Program Counter. Number of times the Quick Start program was run since last reset.
MNL	0	9999	0	Manual Program Counter. Number of times the Manual program was run since last reset.
BRN	0	9999	0	Burn Calories Program Counter. Number of times the Burn Calories program was run since last reset.
INC	0	9999	0	Increase Endurance Program Counter. Number of times the Increase Endurance program was run since last reset.
CHR	0	9999	0	Constant Heart Rate Control Program Counter. Number of times the Constant Heart Rate program was run since last reset.
DHR	0	9999	0	Dynamic Heart Rate Control Program Counter. Number of times the Dynamic Heart Rate program was run since last reset.
BNF	0	9999	0	Burn Fat Program Counter. Number of times the Burn Fat program was run since last reset.
FIT	0	9999	0	Fitness Test Program Counter. Number of times the Fitness Test program was run since last reset.
FIR	0	9999	0	Firefighter Test Program Counter. Number of times Firefighter Test program was run since last reset.
CAL	0	9999	0	Calories Workout Program Counter. Number of times the Calories Workout program was run since last reset.
5KL	0	9999	0	5K Loop Program Counter. Number of times 5K Loop program was run since

Item	Lowest Value	Highest Value	Default Value	Meaning
10K	0	9999	0	last reset. 10K Loop Program Counter. Number of times 10K Loop program was run since last reset.
CST	0	9999	0	Custom Distance Program Counter. Number of times Custom Distance program was run since last reset.
DSP	N/A	N/A	N/A	Display Test. Access to integral Display Test function (for use by authorized Maintenance Technician).
KPT	N/A	N/A	N/A	Keypad Test. Access to integral Keypad Test function (for use by authorized Maintenance Technician).
MTT	N/A	N/A	N/A	Motor Test. Access to integral Motor Test function (for use by authorized Maintenance Technician).
BRN	N/A	N/A	N/A	Burn Mode. Access to integral Burn Mode function (for use by authorized Maintenance Technician).
HRT	N/A	N/A	N/A	Heart Rate Test. Access to integral Heart Rate Test function (for use by authorized Maintenance Technician).
LEL				Last Error List. A log of the last five errors.

TROUBLESHOOTING

STAR TRAC S SERIES TREADMILLS perform a self-test at the beginning of every workout. If a problem is detected, a message displays before or after the workout, depending on the nature of the problem. Star Trac recommends that you refer your questions about your **STAR TRAC S SERIES TREADMILL** operation and suspected malfunctions to Star Trac's Service Hotline at (800) 503-1221, or USA 1-714-669-1660.

START-UP SERVICE MESSAGES

The following messages are displayed at the beginning of a workout if the associated problem is detected during self-test.

NO STOP - This error generally occurs when the Stop Switch is not connected tightly to the circuit board of the Display Control Panel. It may also happen if the circuitry associated with the switch develops a fault. When you see **NO STOP**:

- Set the **ON/OFF** switch to **OFF**; wait 2 seconds.
- Set the **ON/OFF** switch to **ON**. Notify Star Trac if additional assistance is needed.

KEY DOWN - This error generally occurs when a key is held pressed while the **ON/OFF** switch is moved to **ON**. It may also happen if a key becomes stuck. When you see **KEY DOWN**:

- Set the **ON/OFF** switch to **OFF**; wait 2 seconds.
- Set the **ON/OFF** switch to **ON**. The treadmill should be operational again. Notify Star Trac if additional assistance is needed.

SPEED CHANGE: This error generally occur when the running belt speed sensor is disconnected, faulty, or misaligned relative to the revolutions-per-minute (RPM) sensor of the motor. It may also occur if the speed sensor cable is damaged, or if the Motor Control Board (MCB) is misadjusted or faulty. When you see **SPEED CHANGE**:

- Set the **ON/OFF** switch to **OFF**; wait 2 seconds.
- Set the **ON/OFF** switch to **ON**. Notify Star Trac if additional assistance is needed.

ELEVATION STALL, ELEVATION RANGE OR ELEVATION LOST: These errors generally occur when the elevation (incline) potentiometer is faulty or out of limits, or the elevation motor is disconnected or receiving low power. They may also occur if the Motor Control Board (MCB) is faulty or the motor gears are stripped. They are usually accompanied by failure of the treadmill to rise from an elevation other than maximum (or descend from an elevation other than minimum), with attendant beep indication, when (or) is pressed. When you see **ELEVATION STALL, ELEVATION RANGE OR ELEVATION LOST**:

- Notify Star Trac for diagnosis and disposition.

REGULATORY INFORMATION

FCC AND OTHER DOMESTIC / INTERNATIONAL REGULATIONS

The **STAR TRAC S SERIES TREADMILLS** have been tested and found to comply with the limits for a Class A digital device, pursuant to Part 15 of FCC rules. Under the FCC guidelines, operation is subject to the following two guidelines: (1) this device may not cause harmful interference, and (2) this device must accept any interference received, including interference that may cause undesired operation.

The **STAR TRAC S SERIES TREADMILLS** generate and use radio frequency energy. If the products are not installed and used in accordance with the instructions provided in the owner's manual, interference with radio communications may occur. Likewise, if unapproved accessories are installed, interference with radio communications may occur. The intent of the FCC Class A limit is to provide reasonable protection against harmful interference in a residential installation. However, there is no guarantee that interference may not occur in a specific installation. In the event that interference is experienced, turn off the unit to verify that it is in fact the source. If the interference clears with the unit off, then try each of the following measures and combinations thereof:

- Reorient or relocate the treadmill.
- Reorient or relocate the receiving antenna of your television, radio, and / or VCR recorder.
- Connect the unit to a different power outlet.
- Consult Star Trac Product Support, your authorized dealer, or a qualified radio / television technician for assistance.

This product has been tested to meet the following standards:

- UL 1647 (Safety for Motor operated Message and Exercise Machines).
- CAN/CSA – E335-1/3E -94- Safety of household and Similar appliance

INTERNATIONAL REGULATIONS

This product conforms to the requirements of the European Council directives:

- 89/336/ECC, Electromagnetic Compatibility
- 92/590/EEC, General Product Safety Directives
- 73/23/EEC, Electrical equipment Low Voltage Safety Directive

Under the Directive and in addition to Domestic standards, the product also has been tested to meet the following international standards:

EN 60355-1	Safety of the household and Similar Electrical appliance
EN957-1	Safety of Machinery
EN55022	Conducted and Radiated Emission Class A
EN55014-1	Disturbance power
EN55014-2	Immunity
EN60947-5-1	Positive opening mechanism :VDE approval (pending)
EN61000-3-2	Harmonics Current Emission
EN61000-3-3	Flicker and Voltage Fluctuation
EN61000-4-3	Radiated Immunity/ Conducted Immunity
EN61000-4-2	ESD
EN61000-4-4	EFT
EN61000-4-5	Surge
EN61000-4-11	Voltage Dip & Interruption

CORRECT DISPOSAL OF THIS PRODUCT

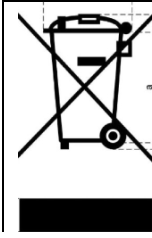

This marking indicates that this product should not be disposed with other household wastes throughout the EU. To prevent possible harm to the environment or human health from uncontrolled waste disposal, recycle it responsibly to promote the sustainable reuse of material resources. To return your used device, please use the return and collection systems or contact the retailer where the product was purchased. They can take this product for environmental safe recycling.



STAR TRAC
14410 Myford Road
Irvine, California 92606
Telephone: (800) 228-6635, (714) 669-1660
Fax: (714) 508-3303
<http://www.startrac.com>
email: support@startrac.com

Part Number 620-6612 Rev B, July 2008